

Dell Latitude E5550 / 5550 Owner's Manual

Regulatory Model: P37F
Regulatory Type: P37F001



Notes, Cautions, and Warnings

 **NOTE:** A NOTE indicates important information that helps you make better use of your computer.

 **CAUTION:** A CAUTION indicates either potential damage to hardware or loss of data and tells you how to avoid the problem.

 **WARNING:** A WARNING indicates a potential for property damage, personal injury, or death.

Copyright © 2014 Dell Inc. All rights reserved. This product is protected by U.S. and international copyright and intellectual property laws. Dell™ and the Dell logo are trademarks of Dell Inc. in the United States and/or other jurisdictions. All other marks and names mentioned herein may be trademarks of their respective companies.

2014 - 12

Rev. A01

Working on Your Computer

Before Working Inside Your Computer

Use the following safety guidelines to help protect your computer from potential damage and to help to ensure your personal safety. Unless otherwise noted, each procedure included in this document assumes that the following conditions exist:

- You have read the safety information that shipped with your computer.
- A component can be replaced or--if purchased separately--installed by performing the removal procedure in reverse order.

 **WARNING:** Disconnect all power sources before opening the computer cover or panels. After you finish working inside the computer, replace all covers, panels, and screws before connecting to the power source.

 **WARNING:** Before working inside your computer, read the safety information that shipped with your computer. For additional safety best practices information, see the Regulatory Compliance Homepage at www.dell.com/regulatory_compliance

 **CAUTION:** Many repairs may only be done by a certified service technician. You should only perform troubleshooting and simple repairs as authorized in your product documentation, or as directed by the online or telephone service and support team. Damage due to servicing that is not authorized by Dell is not covered by your warranty. Read and follow the safety instructions that came with the product.

 **CAUTION:** To avoid electrostatic discharge, ground yourself by using a wrist grounding strap or by periodically touching an unpainted metal surface, such as a connector on the back of the computer.

 **CAUTION:** Handle components and cards with care. Do not touch the components or contacts on a card. Hold a card by its edges or by its metal mounting bracket. Hold a component such as a processor by its edges, not by its pins.

 **CAUTION:** When you disconnect a cable, pull on its connector or on its pull-tab, not on the cable itself. Some cables have connectors with locking tabs; if you are disconnecting this type of cable, press in on the locking tabs before you disconnect the cable. As you pull connectors apart, keep them evenly aligned to avoid bending any connector pins. Also, before you connect a cable, ensure that both connectors are correctly oriented and aligned.

 **NOTE:** The color of your computer and certain components may appear differently than shown in this document.

To avoid damaging your computer, perform the following steps before you begin working inside the computer.

1. Ensure that your work surface is flat and clean to prevent the computer cover from being scratched.
2. Turn off your computer (see [Turning off Your Computer](#)).

3. If the computer is connected to a docking device (docked), undock it.

 **CAUTION: To disconnect a network cable, first unplug the cable from your computer and then unplug the cable from the network device.**

4. Disconnect all network cables from the computer.
5. Disconnect your computer and all attached devices from their electrical outlets.
6. Close the display and turn the computer upside-down on a flat work surface.

 **NOTE: To avoid damaging the system board, you must remove the main battery before you service the computer.**

7. Remove the [base cover](#).
8. Remove the main [battery](#).
9. Turn the computer top-side up.
10. Open the display.
11. Press and hold the power button for few seconds, to ground the system board.

 **CAUTION: To guard against electrical shock, always unplug your computer from the electrical outlet before opening the display.**

 **CAUTION: Before touching anything inside your computer, ground yourself by touching an unpainted metal surface, such as the metal at the back of the computer. While you work, periodically touch an unpainted metal surface to dissipate static electricity, which could harm internal components.**

12. Remove any installed ExpressCards or Smart Cards from the appropriate slots.

Turning Off Your Computer

 **CAUTION: To avoid losing data, save and close all open files and exit all open programs before you turn off your computer.**

1. Shut down the operating system:

- In Windows 8.1:

- Using a touch-enabled device:

- a. Swipe in from the right edge of the screen, opening the Charms menu and select **Settings**.
- b. Select the  and then select **Shut down**.

Or

- * On the Home screen, touch the  and then select **Shut down**.

- Using a mouse:

- a. Point to upper-right corner of the screen and click **Settings**.
- b. Click the  and select **Shut down**.

Or

* On the Home screen, click  and then select **Shut down**.

• In Windows 7:

1. Click **Start** .
2. Click **Shut Down**.

or

1. Click **Start** .
2. Click the arrow in the lower-right corner of the **Start** menu as shown below, and then click



Shut Down

2. Ensure that the computer and all attached devices are turned off. If your computer and attached devices did not automatically turn off when you shut down your operating system, press and hold the power button for about 6 seconds to turn them off.

After Working Inside Your Computer

After you complete any replacement procedure, ensure you connect any external devices, cards, and cables before turning on your computer.

 **CAUTION: To avoid damage to the computer, use only the battery designed for this particular Dell computer. Do not use batteries designed for other Dell computers.**

1. Connect any external devices, such as a port replicator or media base, and replace any cards, such as an ExpressCard.
2. Connect any telephone or network cables to your computer.

 **CAUTION: To connect a network cable, first plug the cable into the network device and then plug it into the computer.**

3. Replace the [battery](#).
4. Replace the [base cover](#).
5. Connect your computer and all attached devices to their electrical outlets.
6. Turn on your computer.

Removing and Installing Components

This section provides detailed information on how to remove or install the components from your computer.

Recommended Tools

The procedures in this document may require the following tools:

- Small flat-blade screwdriver
- #0 Phillips screwdriver
- #1 Phillips screwdriver
- Small plastic scribe

System Overview

Connecting Your Charger

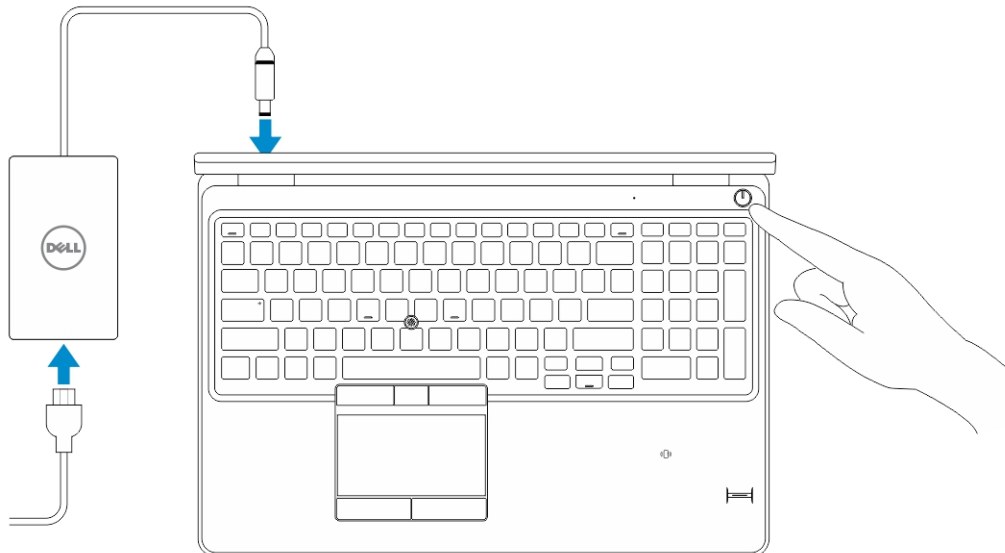

Front and Back View

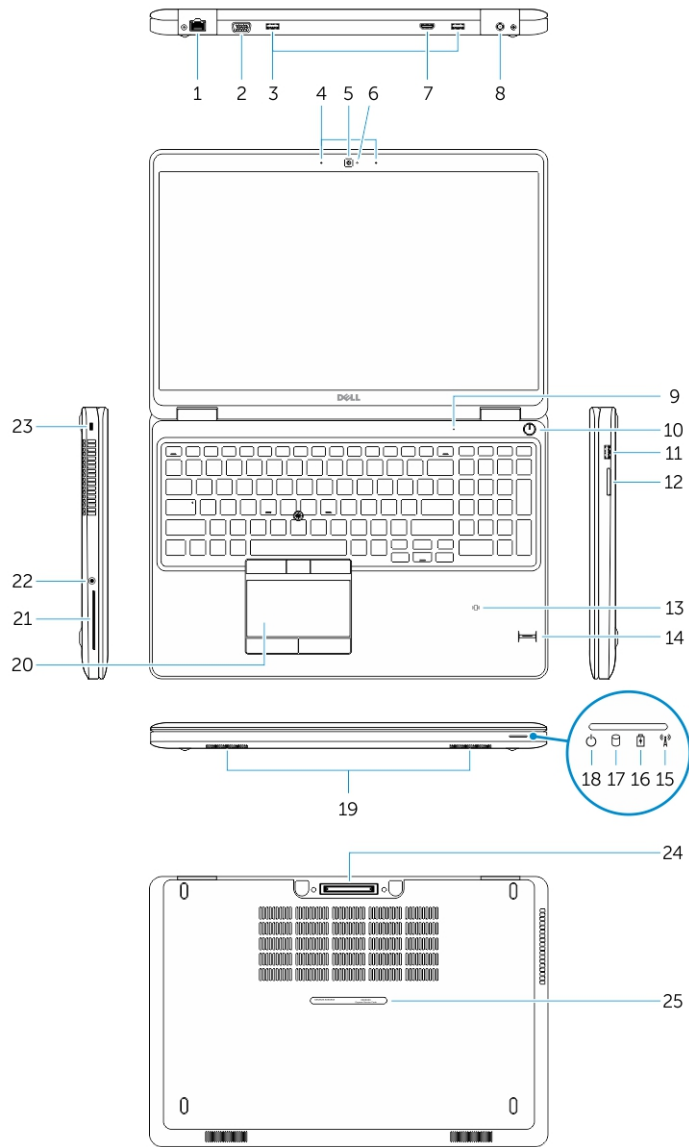

- | | |
|--|-----------------------------------|
| 1. network connector | 2. VGA connector |
| 3. USB 3.0 connector | 4. microphones (optional) |
| 5. camera | 6. camera-status light |
| 7. HDMI connector | 8. power connector |
| 9. microphone | 10. power button |
| 11. USB 3.0 connector with PowerShare | 12. memory-card reader |
| 13. contactless smart-card reader (optional) | 14. fingerprint reader (optional) |

- | | |
|----------------------------------|-------------------------------|
| 15. wireless-status light | 16. battery-status light |
| 17. hard-drive activity light | 18. power-status light |
| 19. speakers | 20. touchpad |
| 21. smart-card reader (optional) | 22. headset connector |
| 23. security-cable slot | 24. dock connector (optional) |
| 25. service-tag label | |

Removing the Base Cover

1. Follow the procedures in [Before Working Inside Your Computer](#).
2. Perform the following steps to remove the base cover from the computer:
 - a. Remove the screws that secure the base cover to the computer.
 - b. Lift the base cover from its edge and remove the base cover from the computer.

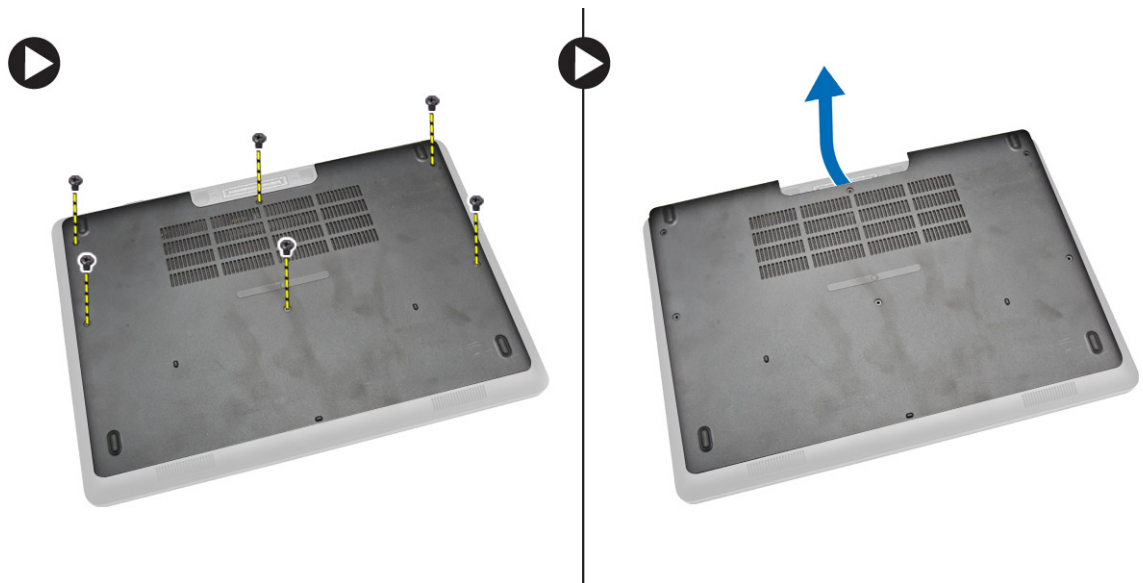

 **NOTE:** You may need a sharp tool to pry the base cover from its edge.

Installing the Base Cover

1. Place the base cover to align with the screw holders on the computer.
2. Tighten the screws to secure the base cover to the computer.
3. Follow the procedures in [After Working Inside Your Computer](#).

Removing the Battery

1. Follow the procedures in [Before Working Inside Your Computer](#).
2. Remove the [base cover](#).
3. Disconnect the battery cable from its connector [1] and release the cable from its routing channel [2].

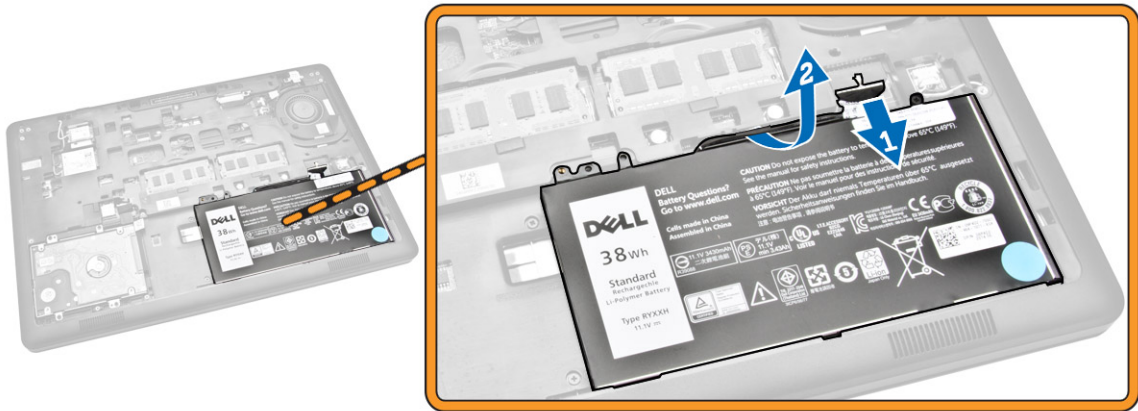

4. Perform the following steps:
 - a. Remove the screw that secures the battery to the computer [1].
 - b. Lift and push to remove the battery from the computer [2] [3].

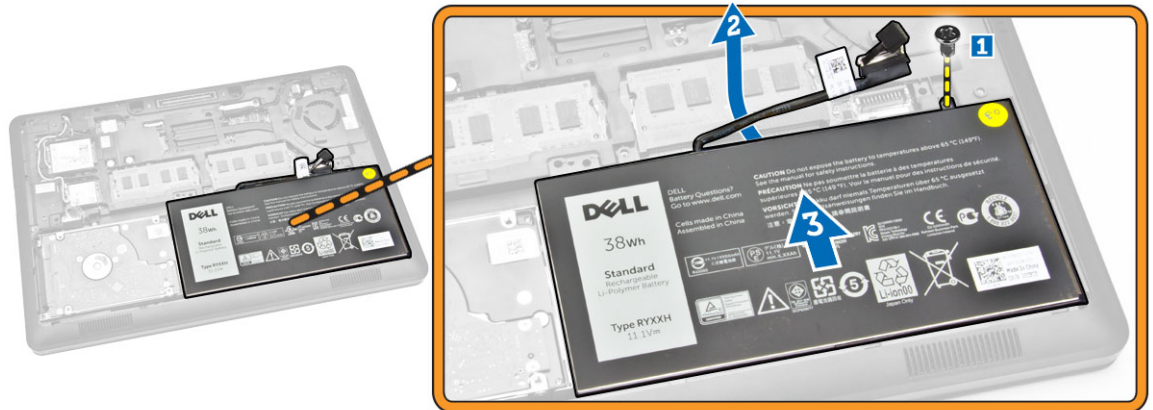

Installing the Battery

1. Insert the battery into its place on the computer.
2. Route the battery cable through its routing channel.
3. Tighten the screw to secure the battery to the computer.
4. Connect the battery cable to its connector on the system board.
5. Install the [base cover](#).
6. Follow the procedures in [After Working Inside Your Computer](#).

Removing the Hard-Drive Assembly

1. Follow the procedure in [Before Working Inside Your Computer](#).
2. Remove the:

- a. [base cover](#)
 - b. [battery](#)
3. Perform the following steps:
- a. Disconnect the hard-drive cable from its connector on the system board [1].
 - b. Remove the screws that secure the hard-drive assembly to the computer [2].

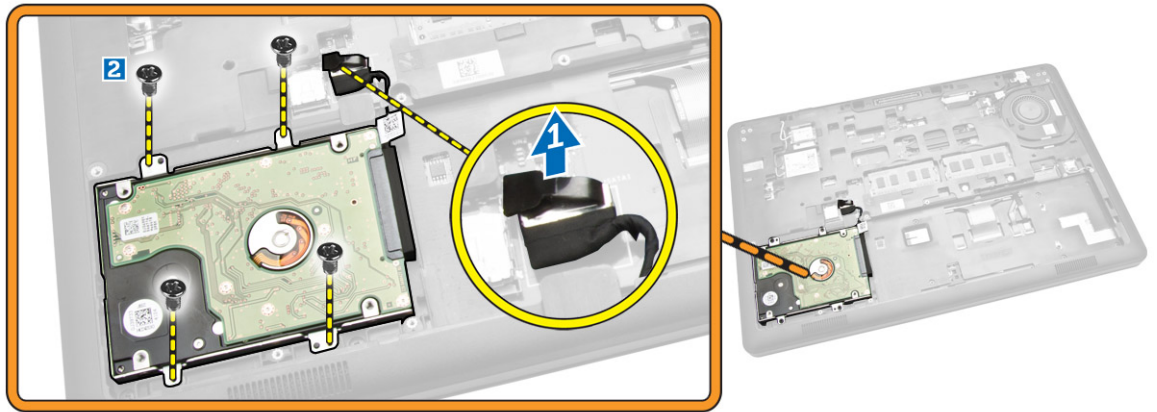

4. Remove the hard-drive assembly from the computer.

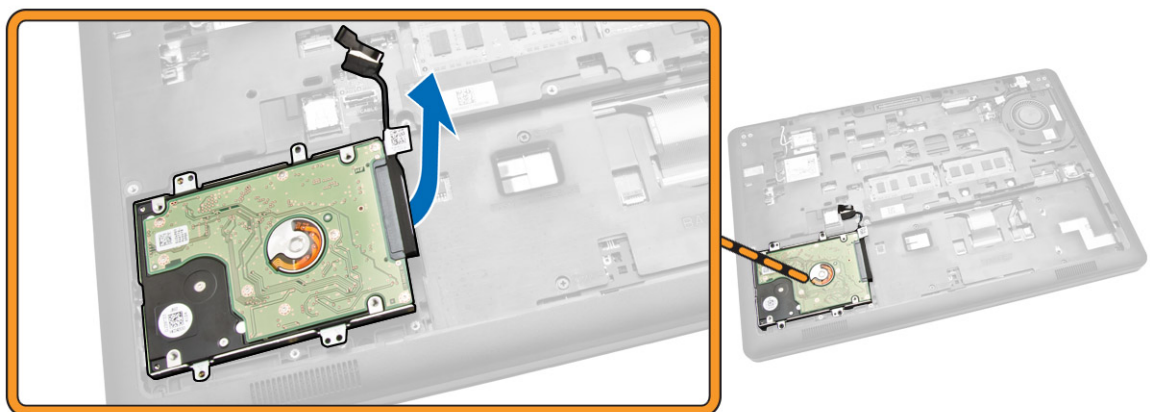

5. Pull to release the hard-drive cable from its connector.

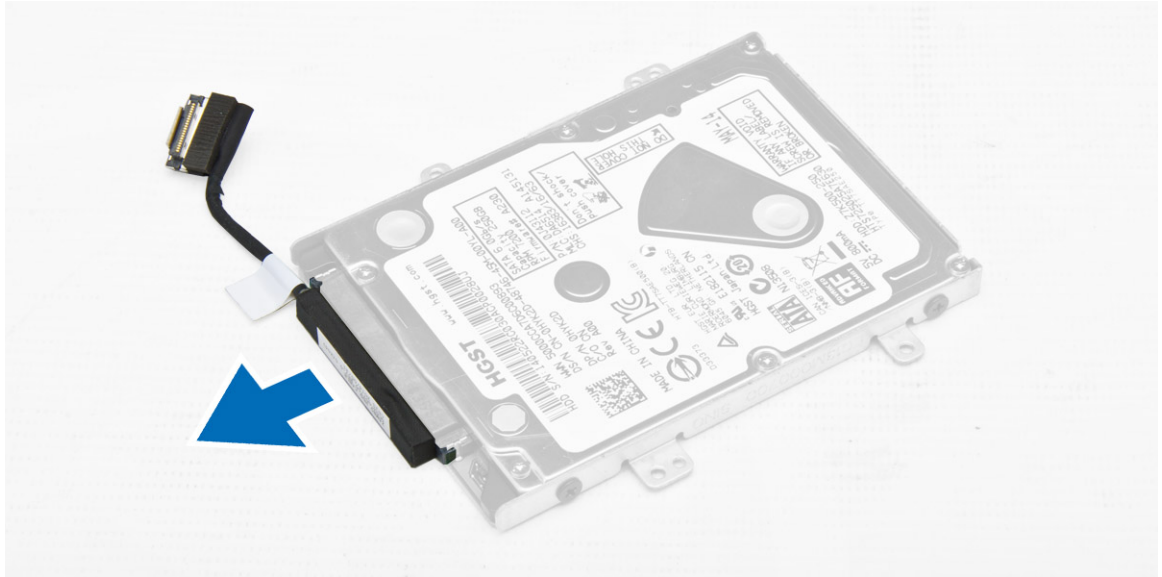

6. Remove the screws that secure the hard-drive bracket to the hard drive [1] and remove the hard drive from the hard-drive bracket [2].

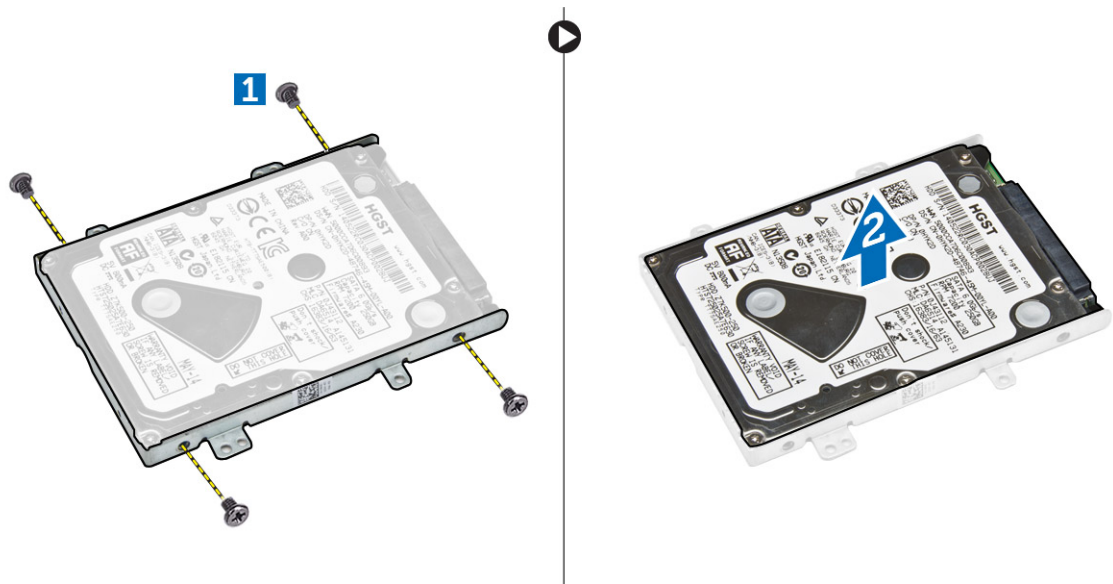

Installing the Hard-Drive Assembly

1. Place the hard-drive bracket on the hard drive to align the screw holders and tighten the screws to secure the hard-drive bracket.
2. Connect the hard-drive cable to its connector on the hard drive.
3. Place the hard-drive assembly into its slot on the computer.
4. Connect the hard-drive cable to its connector on the system board.
5. Tighten the screws to secure the hard-drive assembly to the computer.
6. Install the:

- a. [battery](#)
 - b. [base cover](#)
7. Follow the procedures in [After Working Inside Your Computer](#).

Removing the Memory

1. Follow the procedures in [Before Working Inside Your Computer](#).
2. Remove the:
 - a. [base cover](#)
 - b. [battery](#)
3. Pry the clips securing the memory module until the memory pops-up and remove the memory from the system board.

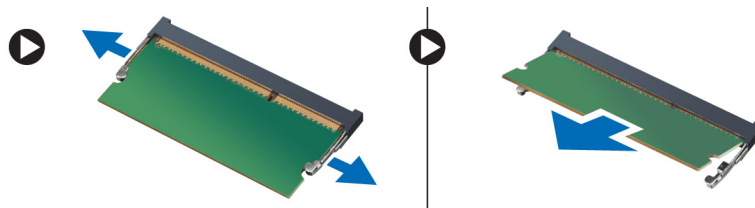



Installing the Memory

1. Insert the memory on the memory socket until the clips secure the memory.
2. Install the:
 - a. [battery](#)
 - b. [base cover](#)
3. Follow the procedures in [After Working Inside Your Computer](#).

Removing the Keyboard Trim

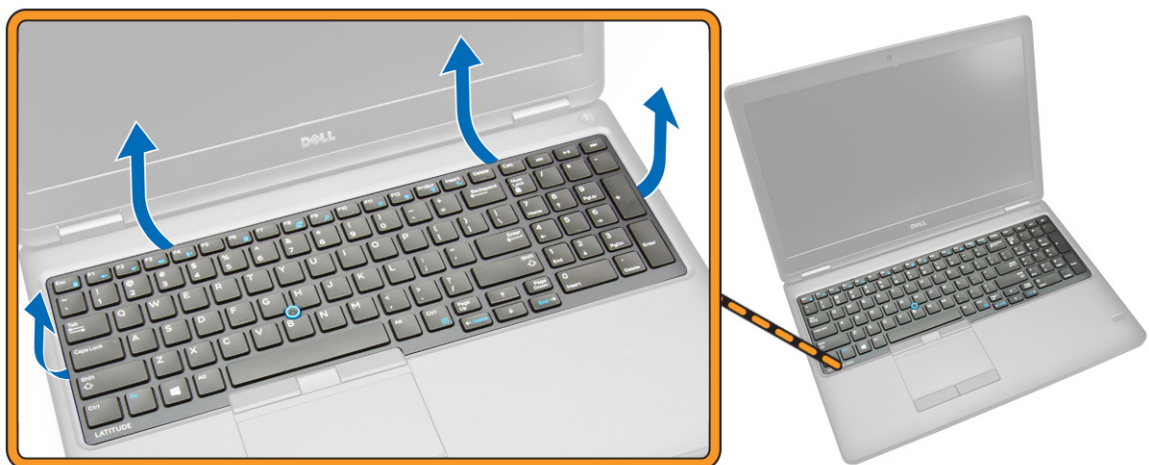
1. Follow the steps in [Before Working Inside Your Computer](#).
2. Pry the keyboard trim from its edges.



 **NOTE:** You may need a sharp tool to pry the keyboard trim from its edges.

3. Remove the keyboard trim from the keyboard.

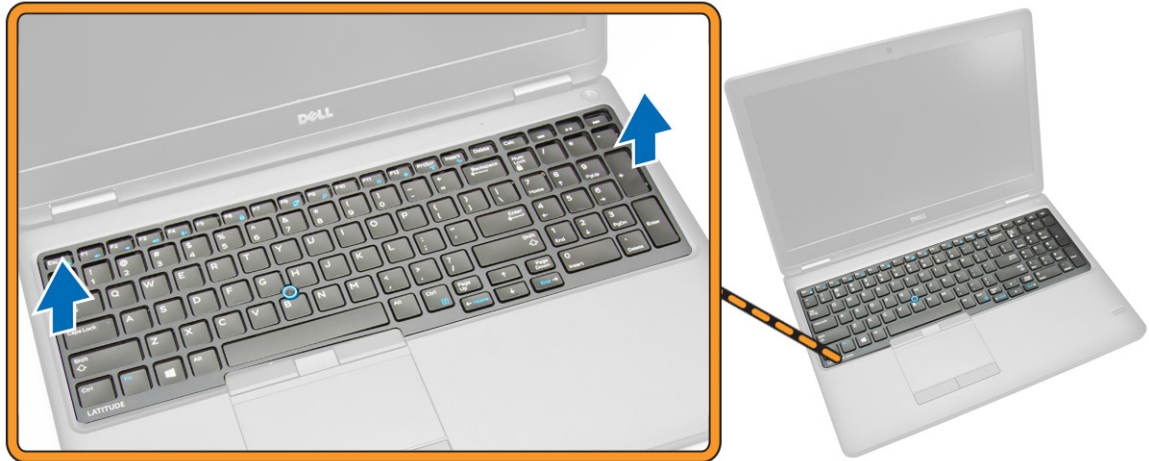

Installing the Keyboard Trim

1. Insert the keyboard trim to the keyboard until it snaps in its place.
2. Follow the procedures in [After Working Inside Your Computer](#).

Removing the Keyboard

1. Follow the procedures in [Before Working Inside Your Computer](#).
2. Remove the:
 - a. [base cover](#)
 - b. [battery](#)
 - c. [keyboard trim](#)
3. Disconnect the keyboard cable and touchpad cables from their connectors on the system board.

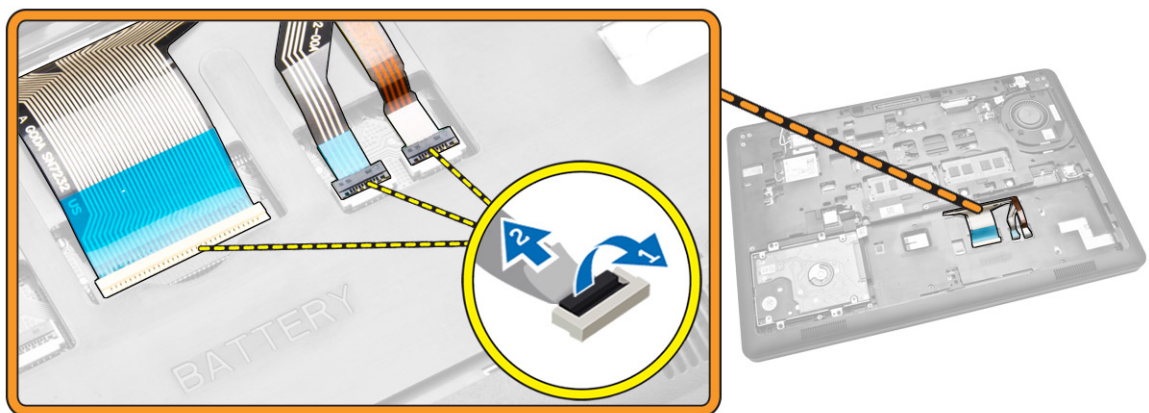

4. Remove the screws that secure the keyboard to the computer.

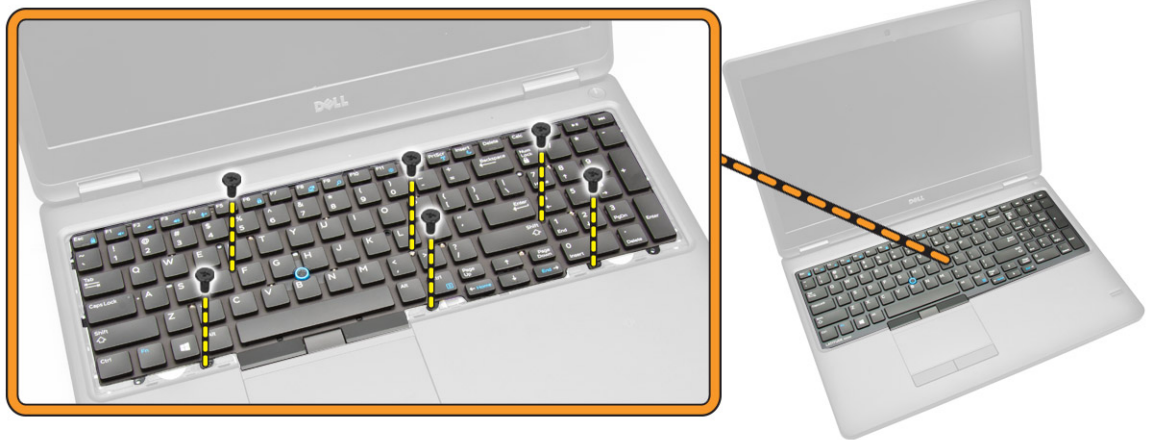

5. Remove the keyboard from the computer.

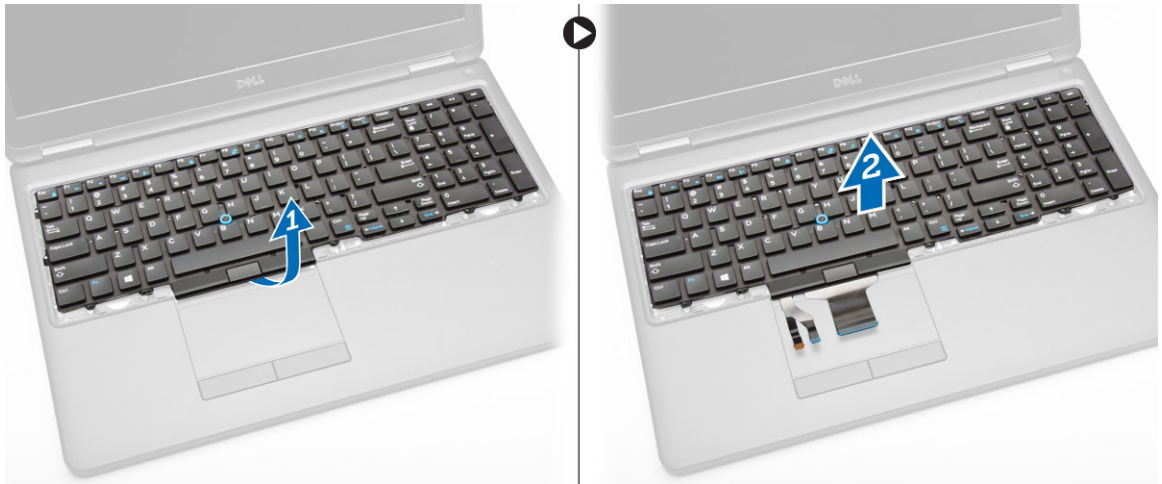

Installing the Keyboard

1. Place the keyboard to align with the screw holders on the computer.
2. Connect the keyboard cable and touchpad cables to their connectors on the system board.
3. Tighten the screws to secure the keyboard to the computer.
4. Install the:
 - a. [keyboard trim](#)
 - b. [battery](#)
 - c. [base cover](#)
5. Follow the procedures in [After Working Inside Your Computer](#).

Removing the Palmrest

1. Follow the procedures in [Before Working Inside Your Computer](#).
2. Remove the:

- a. [base cover](#)
 - b. [battery](#)
 - c. [keyboard trim](#)
 - d. [keyboard](#)
3. Remove the screws that secure the palmrest to the computer.

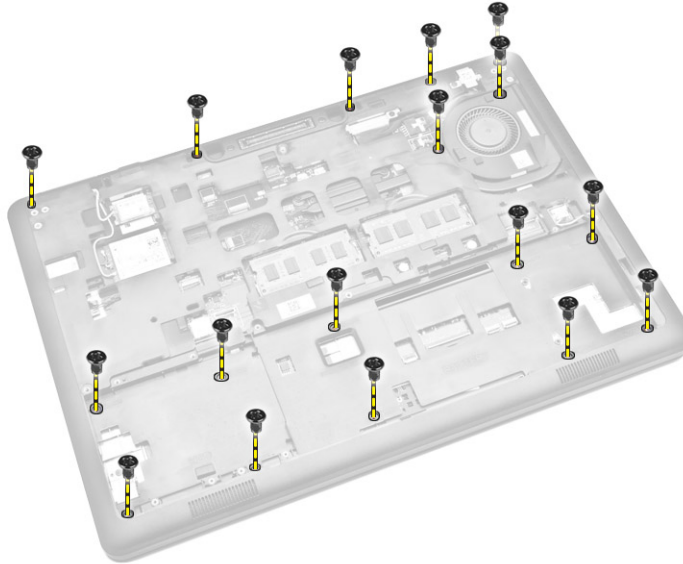

4. Flip the computer and perform the following steps:
- a. Disconnect the following cables from its connectors on the system board [1] [2].
 - power board
 - LED board
 - USH board
 - touchpad board
 - b. Remove the screws that secure the palmrest to the computer [3].

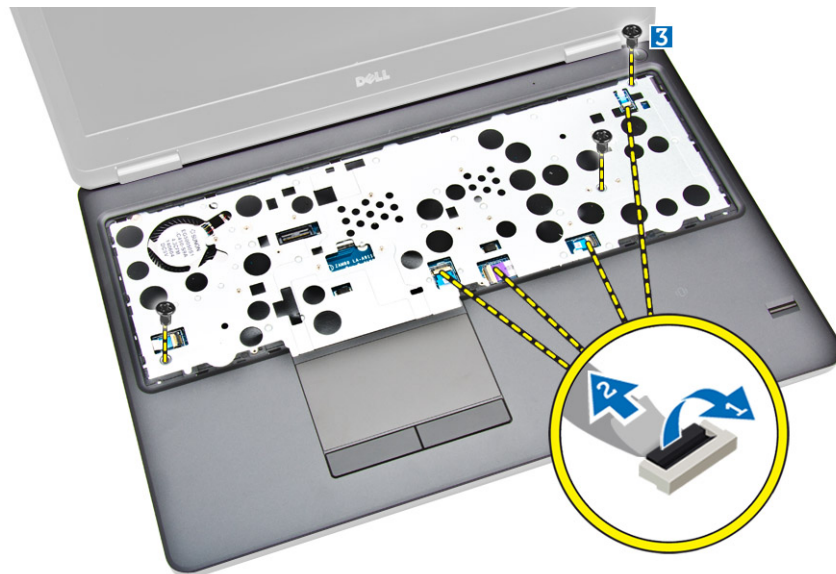

5. Push the palmrest to release and remove the palmrest from the computer [2].

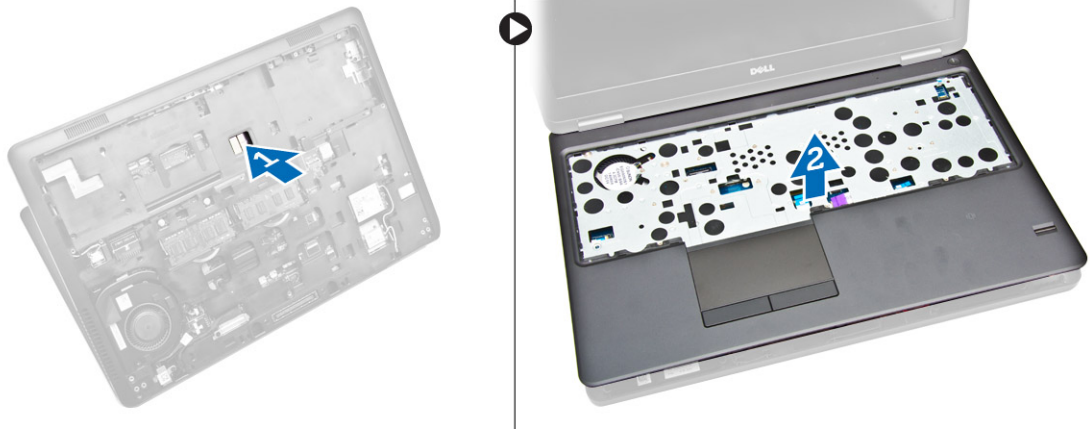

Installing the Palmrest

1. Place the palmrest on the computer.
2. Connect the following cables to their connectors on the system board:
 - a. power board
 - b. LED board
 - c. USH board
 - d. touchpad board
3. Tighten the screws at the front and back of the computer to secure the palmrest.
4. Install the:
 - a. [keyboard](#)
 - b. [keyboard trim](#)
 - c. [battery](#)
 - d. [base cover](#)
5. Follow the procedures in [After Working Inside Your Computer](#)

Removing the Power-Switch Board

1. Follow the procedures in [Before Working Inside Your Computer](#).
2. Remove the:
 - a. [base cover](#)
 - b. [battery](#)
 - c. [keyboard trim](#)
 - d. [keyboard](#)
 - e. [palmrest](#)
3. Perform the following steps to remove the power-switch board from the palmrest:
 - a. Remove the screws that secure the power-switch board to the palmrest [1].
 - b. Remove the power-switch board from the palmrest [2].

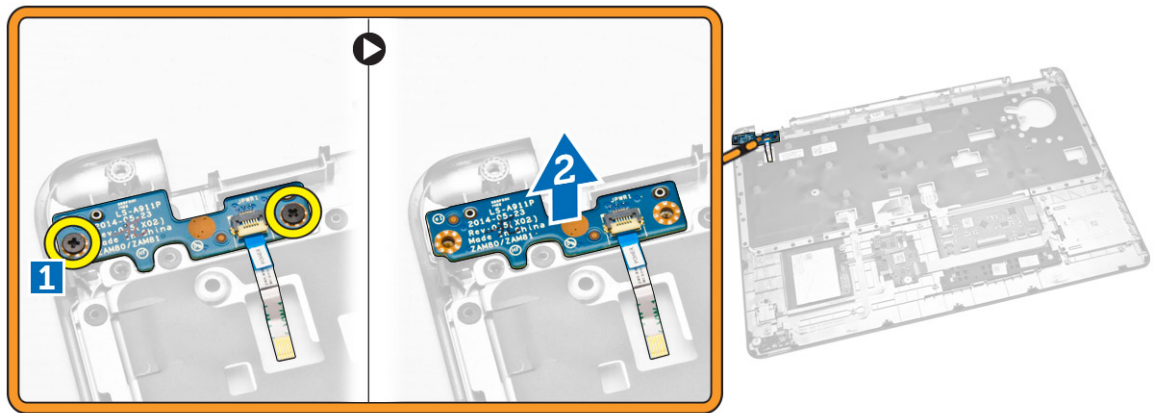

Installing the Power-Switch Board

1. Place the power-switch board to its slot on the palmrest.
2. Tighten the screws to secure the power-switch board to the palmrest.
3. Install the:
 - a. [palmrest](#)
 - b. [keyboard](#)
 - c. [keyboard trim](#)
 - d. [battery](#)
 - e. [base cover](#)
4. Follow the procedures in [After Working Inside Your Computer](#).

Removing the SmartCard Reader Board

1. Follow the procedures in [Before Working Inside Your Computer](#).
2. Remove the:
 - a. [base cover](#)
 - b. [battery](#)
 - c. [memory](#)
 - d. [keyboard trim](#)
 - e. [keyboard](#)
 - f. [palmrest](#)
3. Perform the following steps:
 - a. Disconnect the SmartCard reader board cable from the USH board [1] [2].
 - b. Peel the cable to release from the adhesive [3].

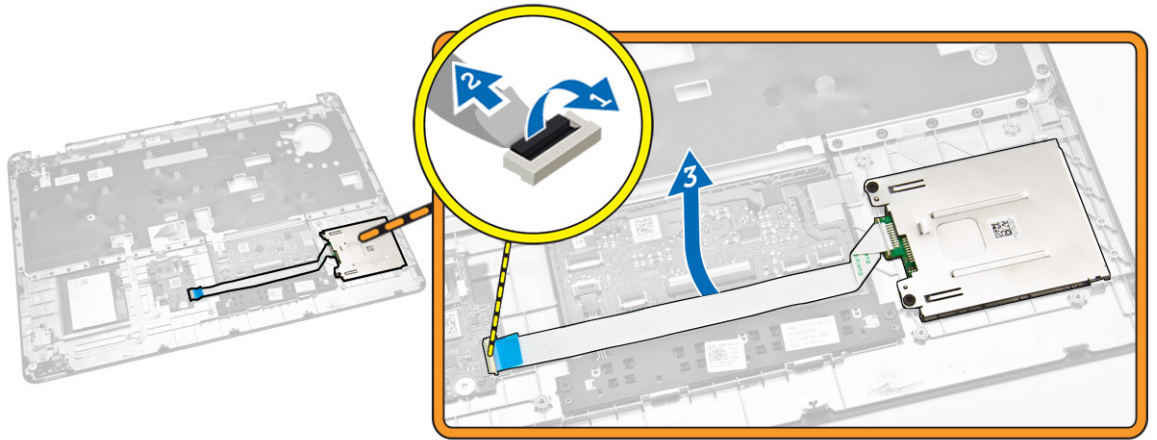

4. Release the SmartCard reader board. To release the SmartCard reader board:
 - a. Remove the screws that secure the SmartCard-reader board to the palmrest [1].
 - b. Push the SmartCard-reader board to release it [2].

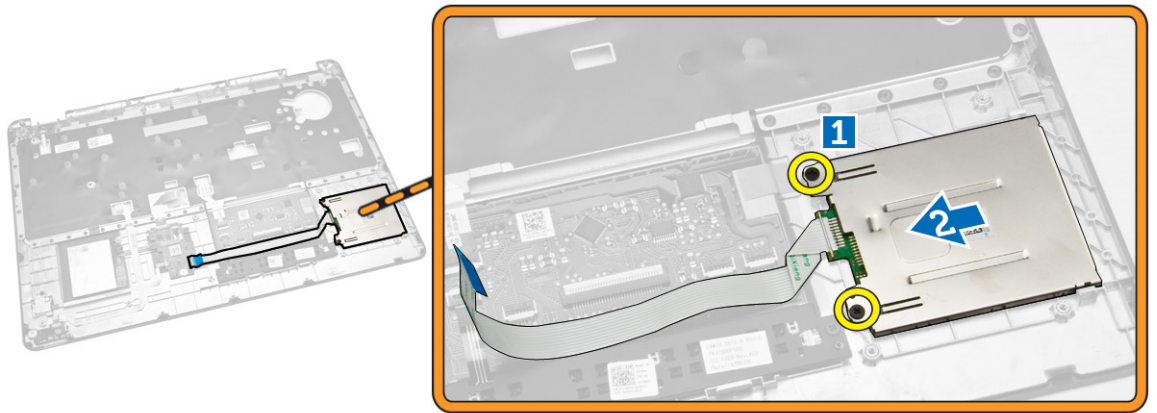

5. Remove the SmartCard reader board from the palmrest.

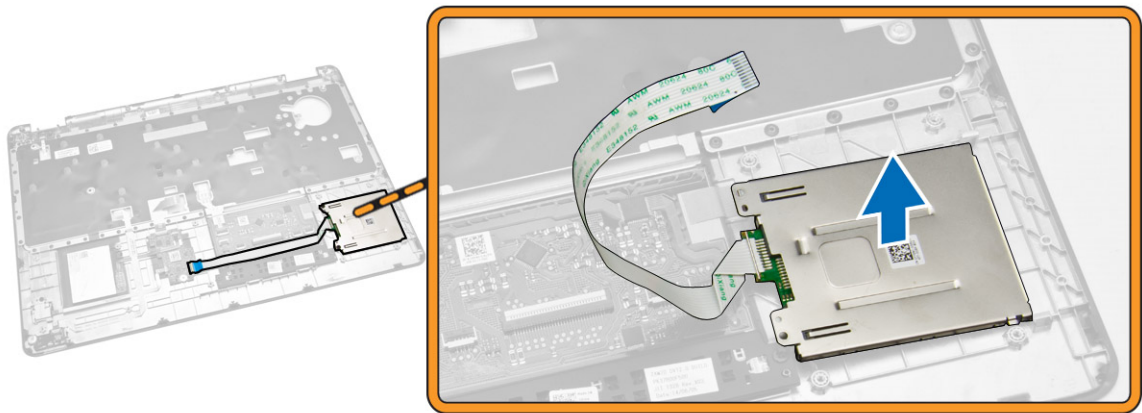

Installing the SmartCard-Reader Board

1. Place the SmartCard-reader board into its slot on the palmrest.
2. Tighten the screws to secure the SmartCard-reader board to the palmrest.
3. Fix the SmartCard-reader cable and connect the SmartCard-reader cable to its connector on the USH board.
4. Install the:
 - a. [palmrest](#)
 - b. [keyboard](#)
 - c. [keyboard trim](#)
 - d. [battery](#)
 - e. [base cover](#)
5. Follow the procedures in [After Working Inside Your Computer](#).

Removing the USH Board

1. Follow the procedures in [Before Working Inside Your Computer](#).
2. Remove the:
 - a. [base cover](#)
 - b. [battery](#)
 - c. [hard-drive assembly](#)
 - d. [keyboard trim](#)
 - e. [keyboard](#)
 - f. [palmrest](#)
3. Perform the following steps to remove the USH board:
 - a. Disconnect all the cables from the USH board [1] [2].
 - b. Remove the screw that secures the USH board to the palmrest [3].
 - c. Remove the USH board from the palmrest [4].

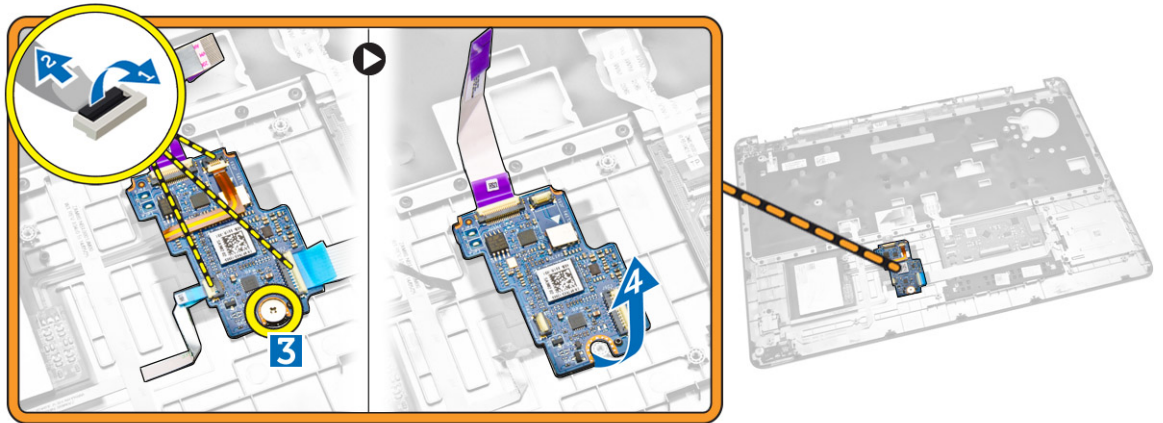

Installing the USH Board

1. Place the USH Board on the palmrest.
2. Tighten the screw to secure the USH board to the palmrest.
3. Connect all the cables to the USH board.
4. Install the:
 - a. [palmrest](#)
 - b. [keyboard](#)
 - c. [keyboard trim](#)
 - d. [hard-drive assembly](#)
 - e. [battery](#)
 - f. [base cover](#)
5. Follow the procedures in [After Working Inside Your Computer](#).

Removing the Finger-Print Reader Board

1. Follow the procedures in [Before Working Inside Your Computer](#).
2. Remove the:
 - a. [base cover](#)
 - b. [battery](#)
 - c. [keyboard trim](#)
 - d. [keyboard](#)
 - e. [palmrest](#)
3. Perform the following steps to remove the finger-print reader board:
 - a. Remove the screw to release the metal bracket that secures the finger-print reader board to the palmrest [1] [2].
 - b. Disconnect the finger-print reader cable from the finger-print reader board [3] [4].
 - c. Remove the finger-print reader board from the palmrest [5].

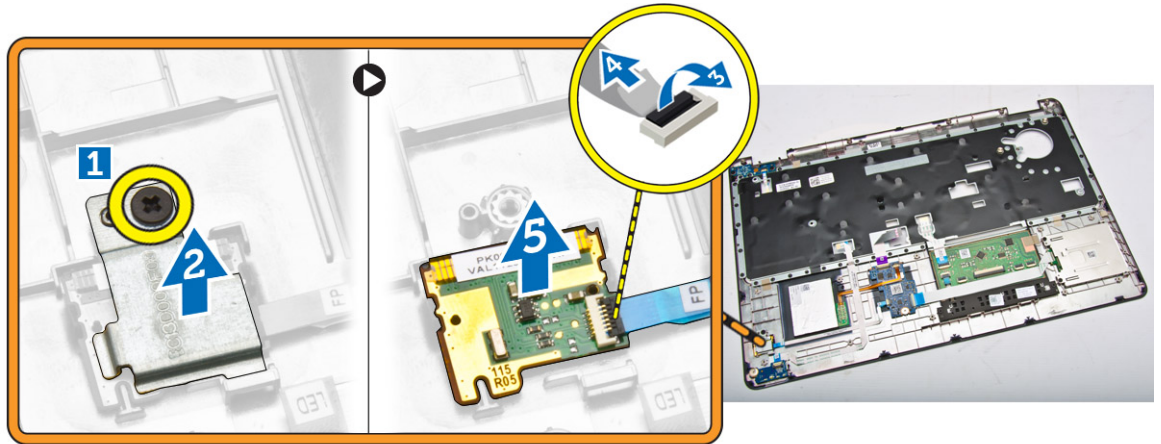

Installing the Finger-Print Reader Board

1. Insert the finger-print reader board into its place on the palmrest.
2. Connect the finger-print reader cable to the finger-print reader board.
3. Place the metal bracket on the finger-print reader board and tighten the screw to secure the finger-print reader board.
4. Install the:
 - a. [keyboard trim](#)
 - b. [keyboard](#)
 - c. [palmrest](#)
 - d. [battery](#)
 - e. [base cover](#)
5. Follow the procedures in [After Working Inside Your Computer](#).

Removing the LED Board

1. Follow the procedures in [Before Working Inside Your Computer](#).
2. Remove the:
 - a. [base cover](#)
 - b. [battery](#)
 - c. [keyboard trim](#)
 - d. [keyboard](#)
 - e. [palmrest](#)
3. Perform the following steps to remove the LED board:
 - a. Disconnect the LED-board cable from its connector on the LED board [1] [2].
 - b. Remove the screw that secures the LED board to the palmrest [3].
 - c. Remove the LED board from the palmrest [4].

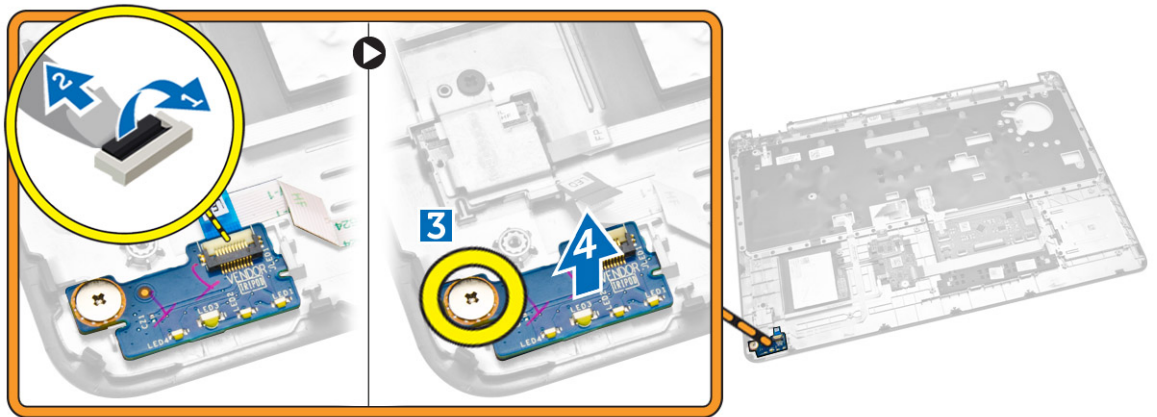

Installing the LED Board

1. Insert the LED board into its slot on the palmrest.
2. Tighten the screw that secures the LED board to the palmrest.
3. Connect the LED-board cable to its connector on the LED board.
4. Install the:
 - a. [palmrest](#)
 - b. [keyboard](#)
 - c. [keyboard trim](#)
 - d. [battery](#)
 - e. [base cover](#)
5. Follow the procedures in [After Working Inside Your Computer](#).

Removing the Power-Connector Port

1. Follow the procedures in [Before Working Inside Your Computer](#).
2. Remove the:
 - a. [base cover](#)
 - b. [battery](#)
3. Disconnect the power-connector port cable from the system board [1] and release the power-connector port cable from its routing channels [2].

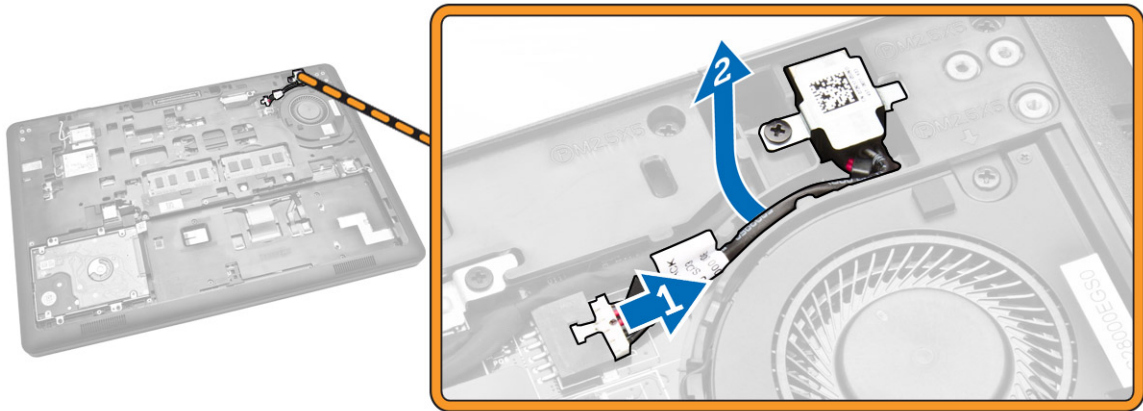

4. Perform the following steps:
 - a. Remove the screw to release the metal bracket on the power-connector port [1] [2].
 - b. Lift and remove the power-connector port from the computer [3].

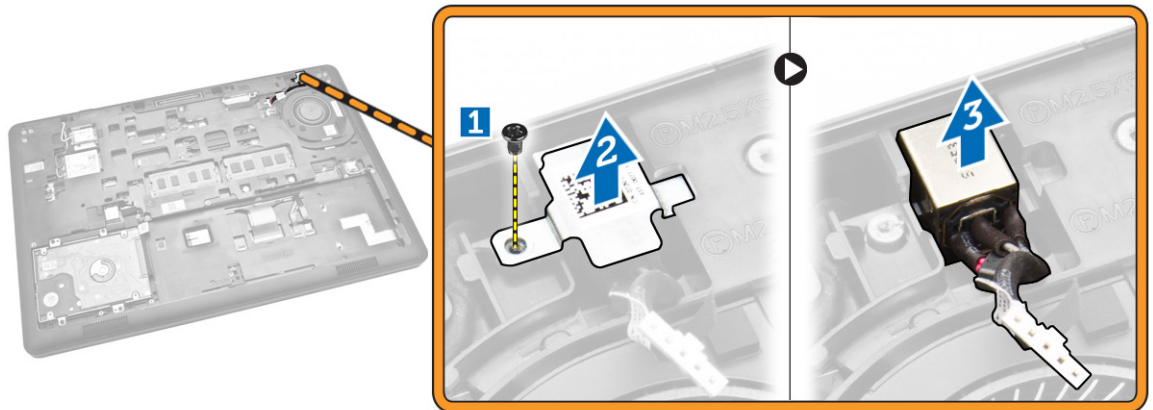

Installing the power-connector port

1. Insert the power-connector port into its place on the computer.
2. Place the metal bracket on the power-connector port and tighten the screw to secure the power-connector port to the computer.
3. Route the power-connector port cable to its routing channels and connect the power-connector port cable to its connector on the system board.
4. Install the:
 - a. [battery](#)
 - b. [base cover](#)
5. Follow the procedures in [After Working Inside Your Computer](#).

Removing the WLAN Card / WiGig Card

 **NOTE:** WiGig card is optional.

1. Follow the procedures in [Before Working Inside Your Computer](#).
2. Remove the [base cover](#).
3. Perform the following steps to remove the WLAN card:
 - a. Disconnect the WLAN cables from their connectors on the WLAN card [1].
 - b. Remove the screw that secures the WLAN card to the computer [2].

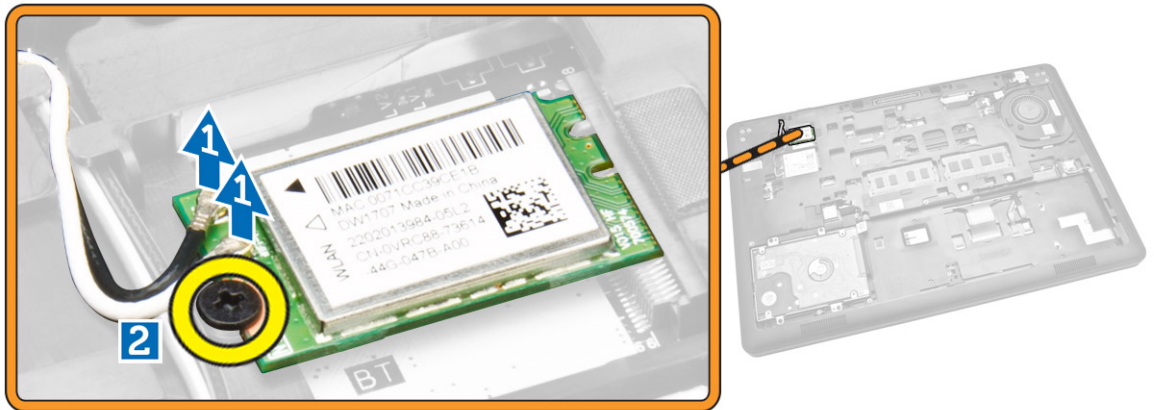

4. Remove the WLAN card from the computer.

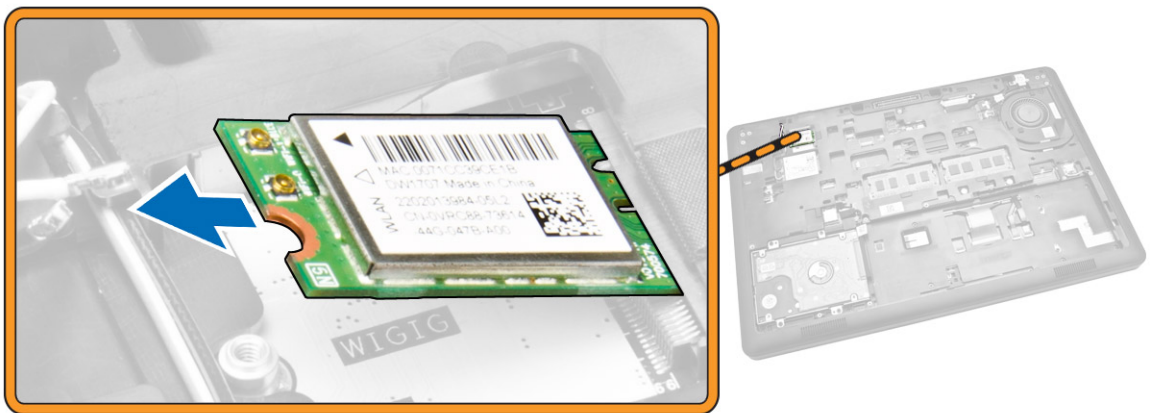

Installing the WLAN Card / WiGig Card

1. Place the WLAN card into its slot on the computer.
2. Tighten the screw to secure the WLAN card to the computer.
3. Connect the WLAN cables to their connectors on the WLAN Card.

4. Install the [base cover](#).
5. Follow the procedures in [After Working Inside Your Computer](#).

Removing the WWAN Card

1. Follow the procedures in [Before Working Inside Your Computer](#).
2. Remove the [base cover](#).
3. Perform the following steps to remove the WWAN card:
 - a. Disconnect the WWAN cables from their connectors on the WWAN card [1].
 - b. Remove the screw that secures the WWAN card to the computer [2].

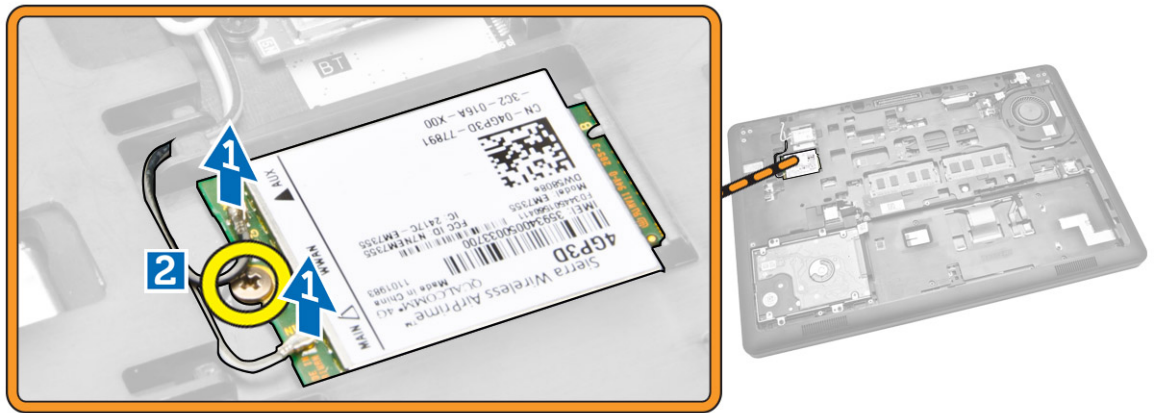

4. Remove the WWAN card from the computer.



Installing the WWAN Card

1. Place the WWAN card into its slot on the computer.
2. Tighten the screw to secure the WWAN card to the computer.
3. Connect the WWAN cables to their connectors on the WWAN Card.

4. Install the [base cover](#).
5. Follow the procedures in [After Working Inside Your Computer](#).

Removing the Display-Hinge Brackets

1. Follow the procedures in [Before Working Inside Your Computer](#).
2. Remove the:
 - a. [base cover](#)
 - b. [battery](#)
 - c. [memory](#)
 - d. [hard-drive assembly](#)
 - e. [keyboard trim](#)
 - f. [keyboard](#)
 - g. [palmrest](#)
3. Remove the screws that secure the display-hinge brackets to the back of the computer.



4. Open the display and perform the following steps:
 - a. Remove the screws that secure the display-hinge brackets to the front of the computer [1].
 - b. Pull the display-hinge brackets to remove from the computer [2].

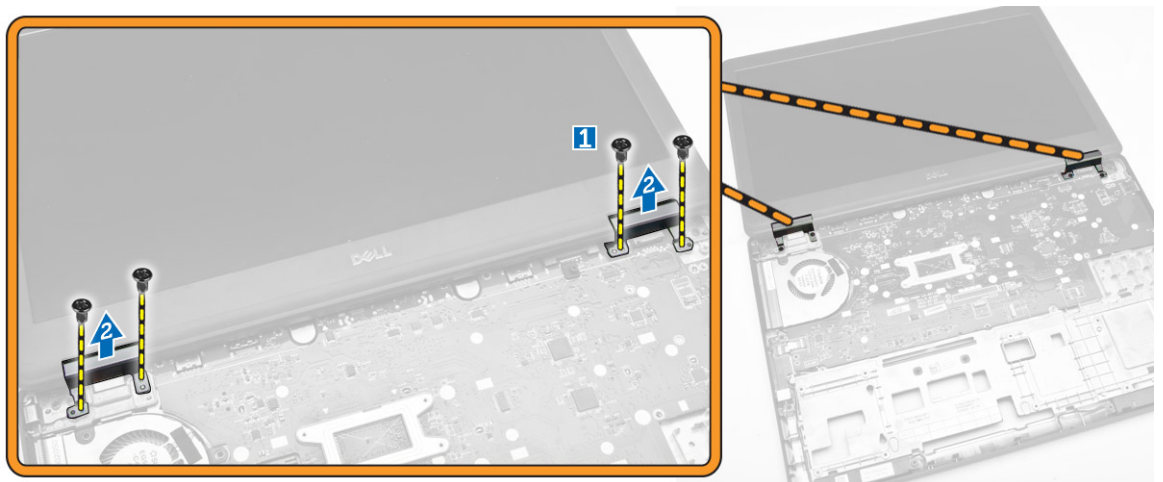

Installing the Display-Hinge Brackets

1. Insert the display-hinge brackets into their slots on the computer.
2. Tighten the screws at the front and back of the computer to secure the display-hinge brackets.
3. Install the:
 - a. [palmrest](#)
 - b. [keyboard](#)
 - c. [keyboard trim](#)
 - d. [hard-drive assembly](#)
 - e. [memory](#)
 - f. [battery](#)
 - g. [base cover](#)
4. Follow the procedures in [After Working Inside Your Computer](#).

Removing the Display Assembly

1. Follow the procedures in [Before Working Inside Your Computer](#).
2. Remove the:
 - a. [base cover](#)
 - b. [battery](#)
 - c. [keyboard trim](#)
 - d. [keyboard](#)
 - e. [palmrest](#)
 - f. [display-hinge brackets](#)
3. Disconnect the WLAN and WWAN cables from their connectors [1] and release the cables through their routing channels [2].



4. Disconnect the display cable from the system board. To disconnect the display cable:
 - a. Remove the screw that secures the display-cable bracket to the computer [1].
 - b. Remove the display-cable bracket to access the display cable [2].
 - c. Disconnect the display cable from the system board [3].

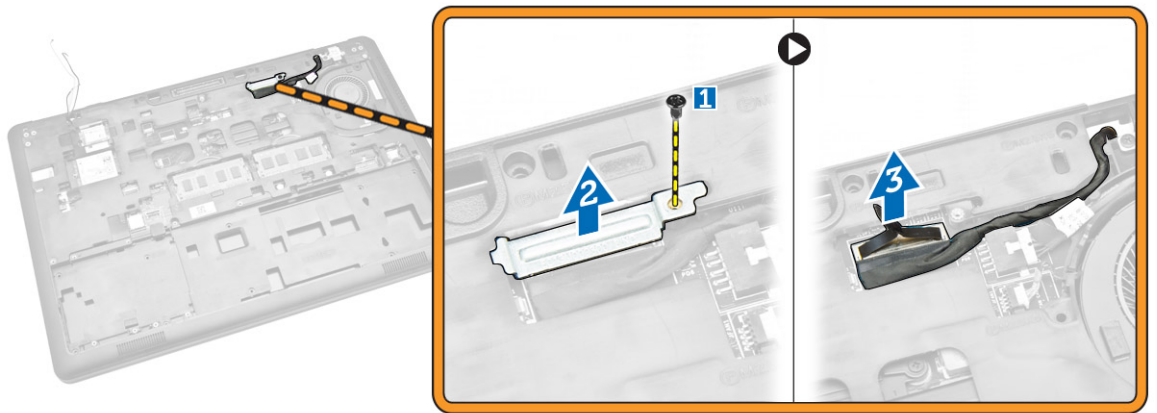

5. Release the display cable from its routing channel.

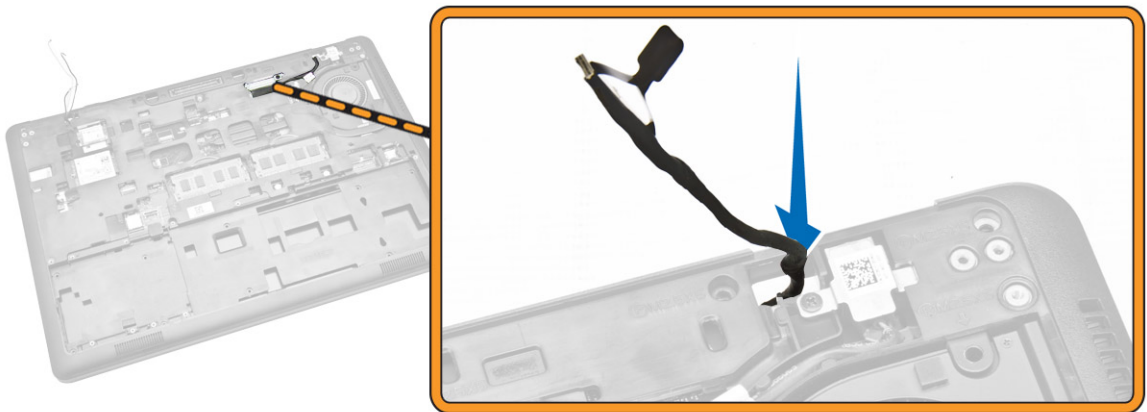

6. Remove the screws that secure the display assembly [1] and lift the display assembly to remove it from the computer [2].



Installing the Display Assembly

1. Place the display assembly to align with the screw holders on the computer.
2. Route the WWAN, WLAN, and display cables through their routing channels.
3. Tighten the screws to secure the display assembly to the computer.
4. Connect the WWAN and WLAN cables to their connectors.
5. Connect the display cable to the system board, place the display-cable bracket over the connector, and tighten the screw to secure the display cable to the computer.
6. Install the:
 - a. [display-hinge brackets](#)
 - b. [palmrest](#)
 - c. [keyboard](#)
 - d. [keyboard trim](#)
 - e. [battery](#)
 - f. [base cover](#)
7. Follow the procedures in [After Working Inside Your Computer](#).

Removing the Display Bezel

1. Follow the procedures in [Before Working Inside Your Computer](#).
2. Pry the edges to release the display bezel from the display assembly.



3. Remove the display bezel from the display assembly.



Installing the Display Bezel

1. Place the display bezel on the display assembly.
2. Starting from the top corner, press on the display bezel and work around the entire bezel until it clicks on to the display assembly.
3. Follow the procedures in [After Working Inside Your Computer](#).

Removing the Display Panel

1. Follow the procedures in [Before Working Inside Your Computer](#).
2. Remove the:
 - a. [base cover](#)
 - b. [battery](#)
 - c. [display bezel](#)
3. Remove the screws that secure the display panel to the display assembly [1] and lift to flip the display panel to access the eDP cable [2].



4. Peel the adhesive [1] to access the eDP cable [2].

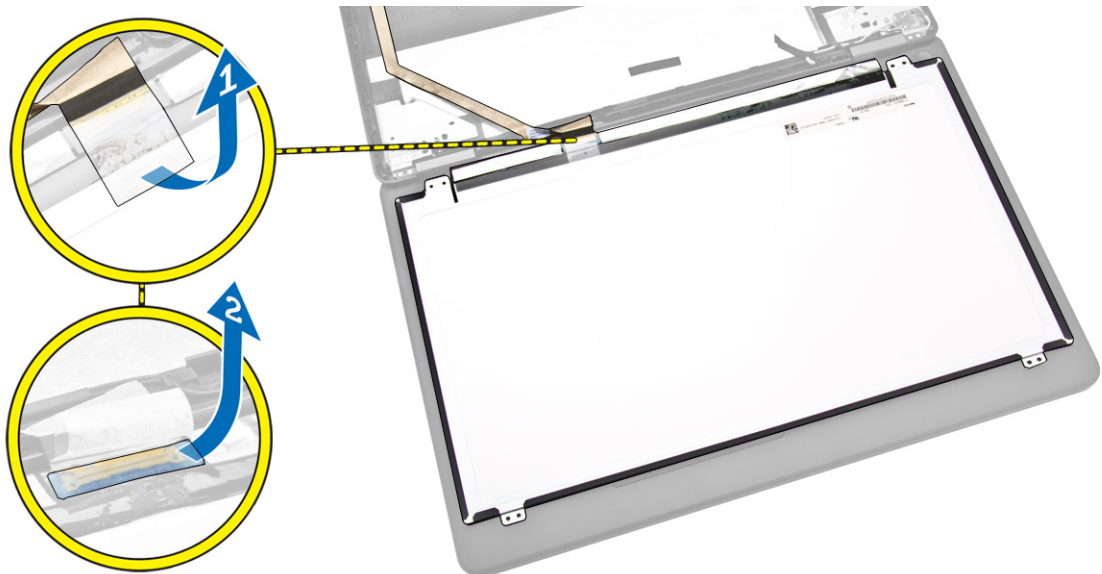

5. Disconnect the eDP cable from its connector [1] and remove the display panel from the display assembly [2].

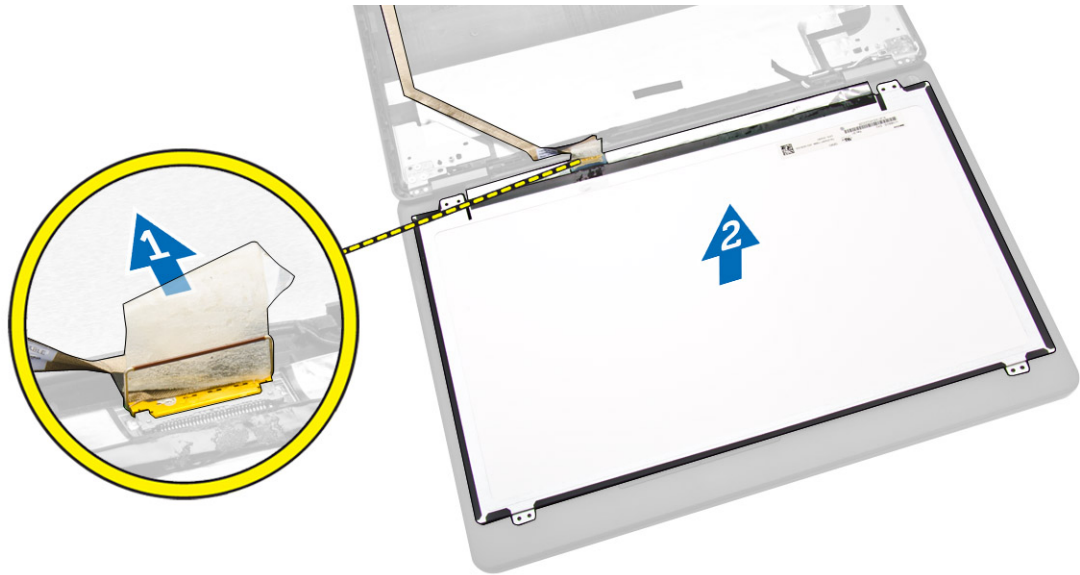

Installing the Display Panel

1. Connect the eDP cable to its connector and fix the adhesive tape.
2. Place the display panel to align with the screw holders on the display assembly.
3. Tighten the screws to secure the display panel to the display assembly.
4. Install the:
 - a. [display bezel](#)
 - b. [battery](#)
 - c. [base cover](#)
5. Follow the procedures in [After Working Inside Your Computer](#).

Removing the Display Hinges

1. Follow the procedures in [Before Working Inside Your Computer](#).
2. Remove the:
 - a. [base cover](#)
 - b. [battery](#)
 - c. [memory](#)
 - d. [hard-drive assembly](#)
 - e. [keyboard trim](#)
 - f. [keyboard](#)
 - g. [palmrest](#)
 - h. [display-hinge brackets](#)
 - i. [display assembly](#)
 - j. [display bezel](#)
3. Perform the following steps to remove the display hinges from the display assembly:
 - a. Remove the screws that secure the display hinges at both sides of the display assembly [1].
 - b. Remove the display hinges from the display assembly [2].

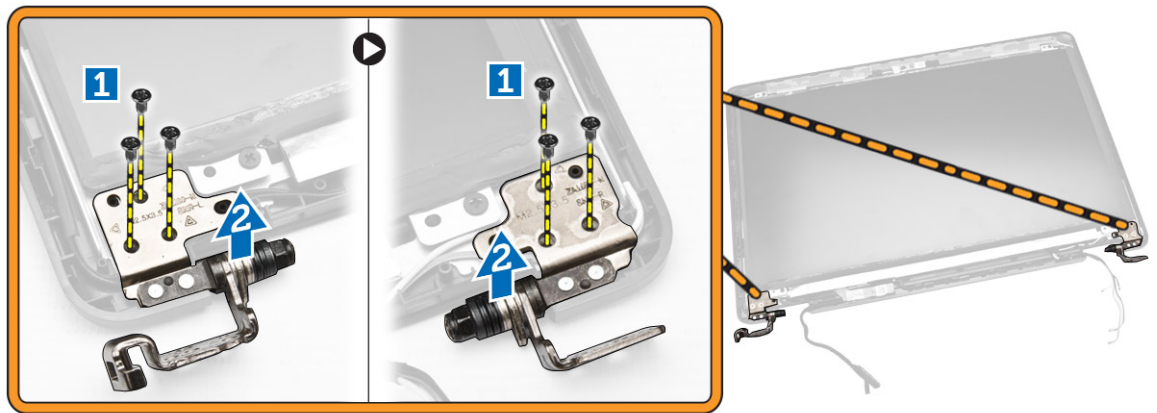

Installing the Display Hinges

1. Insert the display hinges into their slots on the display assembly.
2. Tighten the screws to secure the display hinge on both sides of the display assembly.
3. Install the:
 - a. [display bezel](#)
 - b. [display assembly](#)
 - c. [display-hinge brackets](#)
 - d. [palmrest](#)
 - e. [keyboard](#)
 - f. [keyboard trim](#)
 - g. [hard-drive assembly](#)
 - h. [memory](#)
 - i. [battery](#)
 - j. [base cover](#)
4. Follow the procedures in [After Working Inside Your Computer](#).

Removing the Camera

1. Follow the procedures in [Before Working Inside Your Computer](#).
2. Remove the:
 - a. [base cover](#)
 - b. [battery](#)
 - c. [display bezel](#)
 - d. [display panel](#)
3. Perform the following steps to remove the camera from the computer:
 - a. Lift the camera to release it from the adhesive [1].
 - b. Disconnect the camera cable from its connector [2].
 - c. Remove the camera from the computer [3].

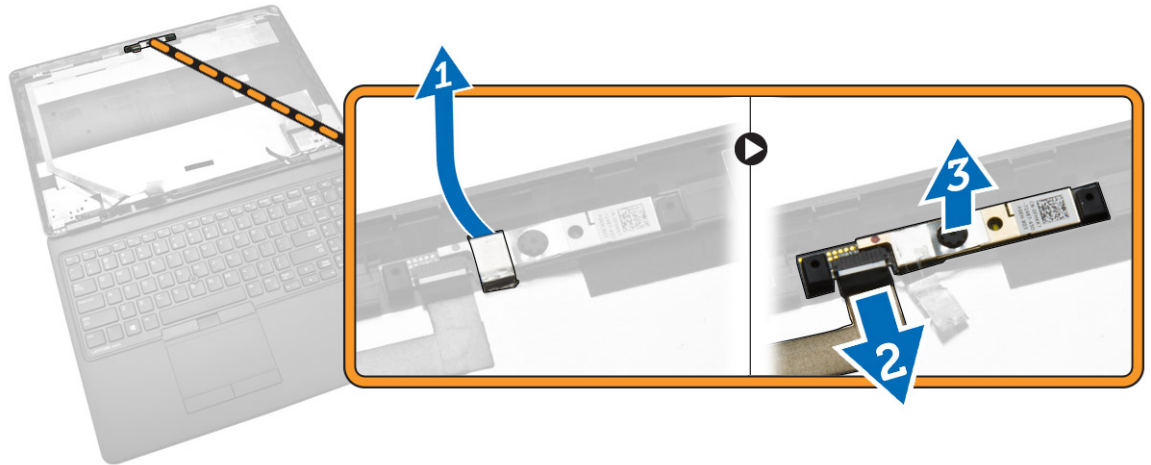

Installing the Camera

1. Insert the camera to its place on the display assembly.
2. Connect the camera cable to its connector.
3. Install the:
 - a. [display panel](#)
 - b. [display bezel](#)
 - c. [battery](#)
 - d. [base cover](#)
4. Follow the procedures in [After Working Inside Your Computer](#).

Removing the eDP Cable

1. Follow the procedures in [Before Working Inside Your Computer](#).
2. Remove the:
 - a. [base cover](#)
 - b. [battery](#)
 - c. [memory](#)
 - d. [hard-drive assembly](#)
 - e. [keyboard trim](#)
 - f. [keyboard](#)
 - g. [palmrest](#)
 - h. [display-hinge brackets](#)
 - i. [display assembly](#)
 - j. [display bezel](#)
 - k. [display panel](#)
3. Perform the following steps to remove the eDP cable from the computer:
 - a. Disconnect the eDP cable from its connector [1].
 - b. Peel the eDP cable [2] and remove the eDP cable from the computer [3].

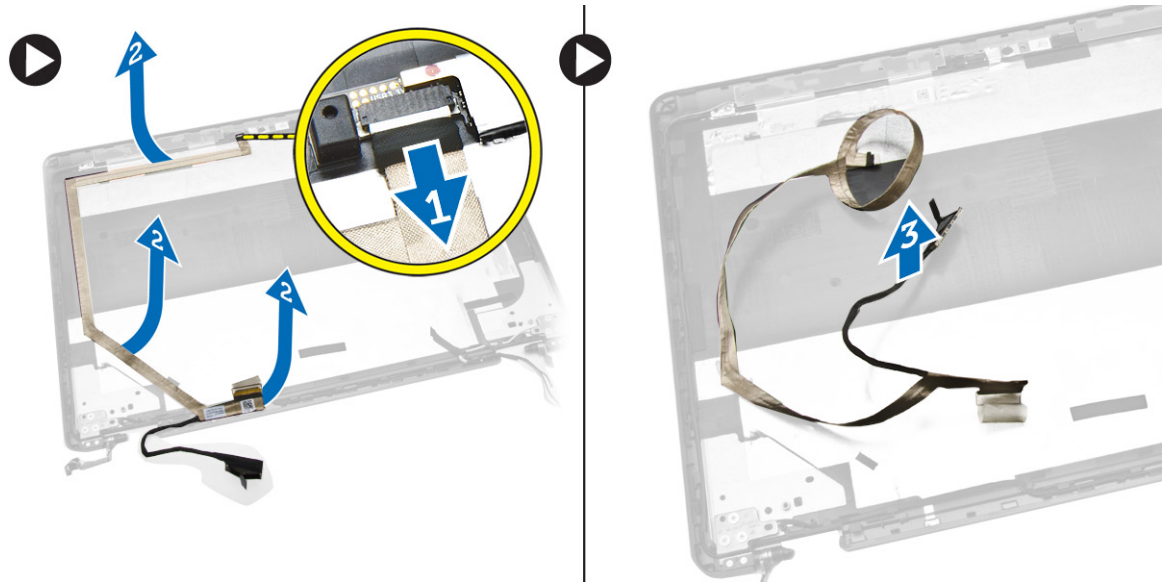

Installing the eDP cable

1. Fix the eDP cable in its place on the display assembly.
2. Connect the eDP cable to its connector.
3. Install the:
 - a. [display panel](#)
 - b. [display bezel](#)
 - c. [display assembly](#)
 - d. [display-hinge brackets](#)
 - e. [palmrest](#)
 - f. [keyboard](#)
 - g. [keyboard trim](#)
 - h. [hard-drive assembly](#)
 - i. [memory](#)
 - j. [battery](#)
 - k. [base cover](#)
4. Follow the procedures in [After Working Inside Your Computer](#).

Removing the System Fan

1. Follow the procedures in [Before Working Inside Your Computer](#).
2. Remove the:
 - a. [base cover](#)
 - b. [battery](#)
 - c. [keyboard trim](#)
 - d. [keyboard](#)
 - e. [palmrest](#)
3. Disconnect the system-fan cable from its connector on the system board.

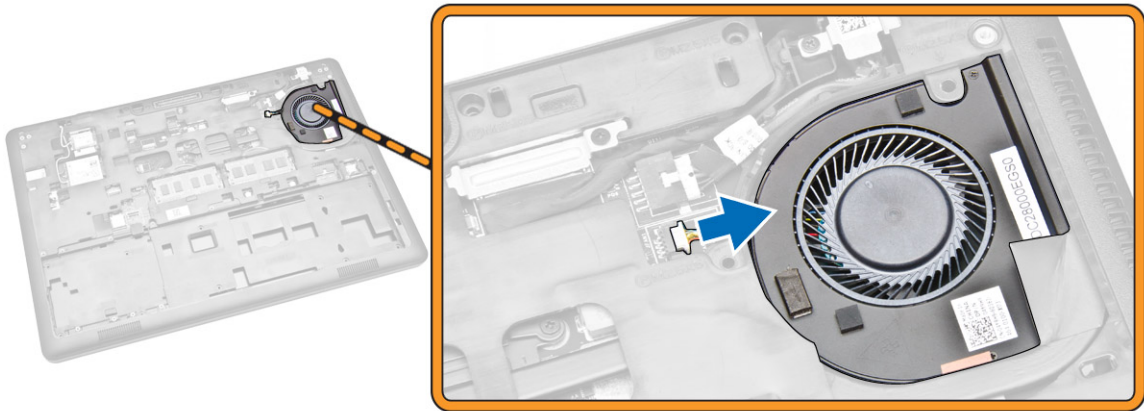

4. Remove the system fan from the computer.

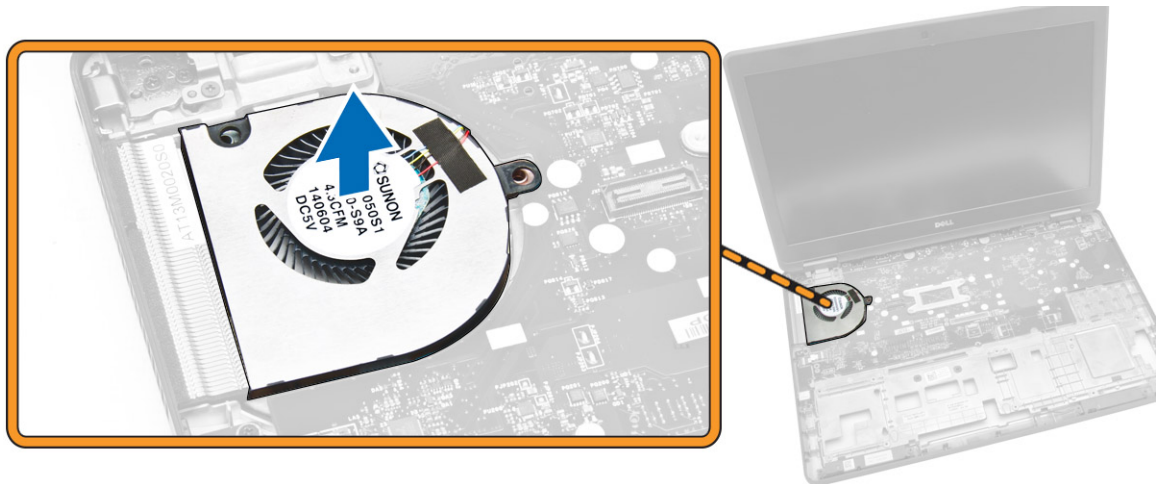

Installing the System Fan

1. Place the system fan into its slot on the computer.
2. Connect the system-fan cable to its connector on the system board.
3. Install the:
 - a. [palmrest](#)
 - b. [keyboard](#)
 - c. [keyboard trim](#)
 - d. [battery](#)
 - e. [base cover](#)
4. Follow the procedures in [After Working Inside Your Computer](#).

Removing the Audio Board

1. Follow the procedures in [Before Working Inside Your Computer](#).
2. Remove the:

- a. [base cover](#)
 - b. [battery](#)
 - c. [keyboard trim](#)
 - d. [keyboard](#)
 - e. [palmrest](#)
3. Perform the following steps to remove the audio board from computer:
- a. Disconnect the audio-board cable from its connector on the system board [1] [2].
 - b. Release the speaker cable from the audio board [3].
 - c. Remove the screws that secure the audio board to the computer [4].
 - d. Lift and remove the audio board from the computer [5].

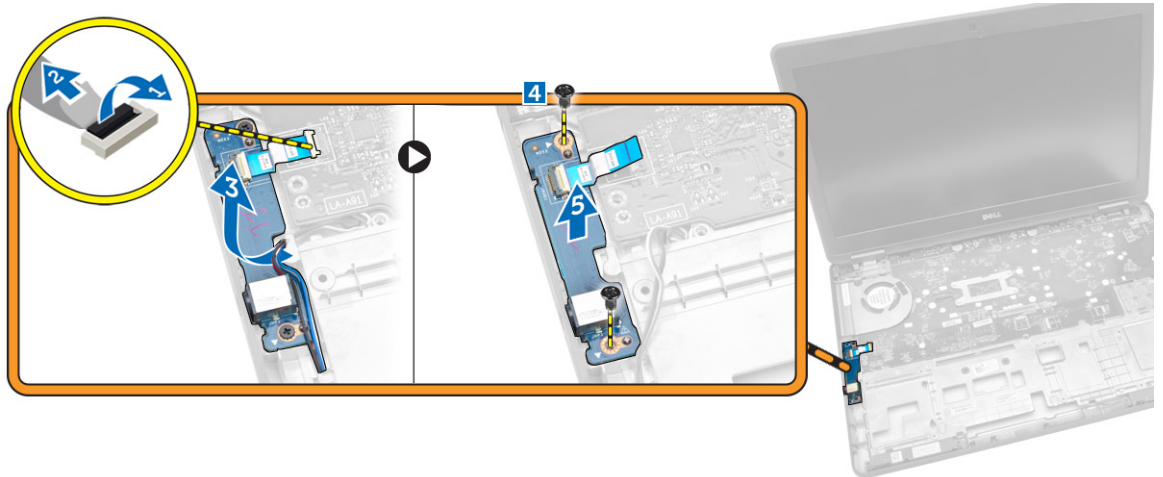

Installing the Audio Board

1. Insert the audio board into its place on the computer.
2. Tighten the screws to secure the audio board to the computer.
3. Route the speaker cable through the routing channel.
4. Connect the audio-board cable to its connector on the system board.
5. Install the:
 - a. [palmrest](#)
 - b. [keyboard](#)
 - c. [keyboard trim](#)
 - d. [battery](#)
 - e. [base cover](#)
6. Follow the procedures in [After Working Inside Your Computer](#).

Removing the System Board

1. Follow the procedures in [Before Working Inside Your Computer](#).
2. Remove the:
 - a. [base cover](#)
 - b. [battery](#)
 - c. [memory](#)

- d. [hard-drive assembly](#)
 - e. [keyboard trim](#)
 - f. [keyboard](#)
 - g. [palmrest](#)
 - h. [display-hinge brackets](#)
 - i. [display assembly](#)
 - j. [system fan](#)
3. Disconnect the speaker cable [1] and power-connector cable [2] from the system board.

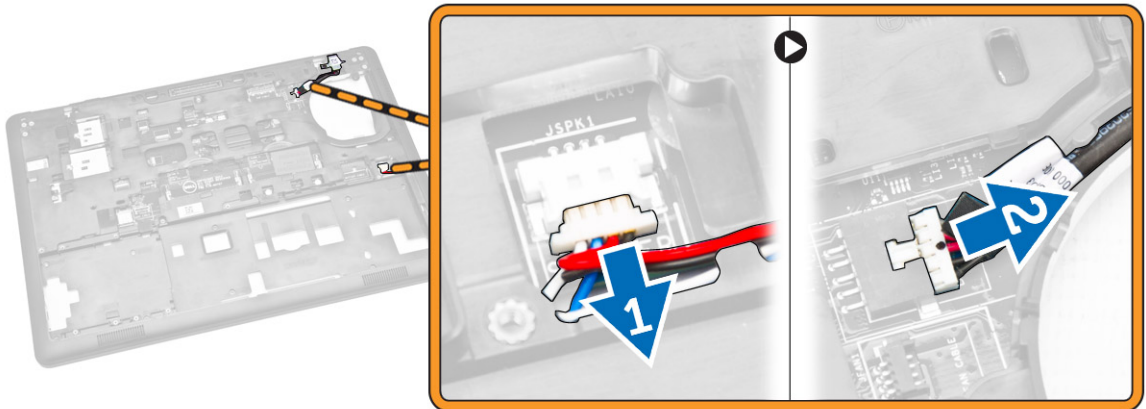

4. Disconnect the audio-board cable [1] [2] and remove the screws that secure the system board to the computer [3].

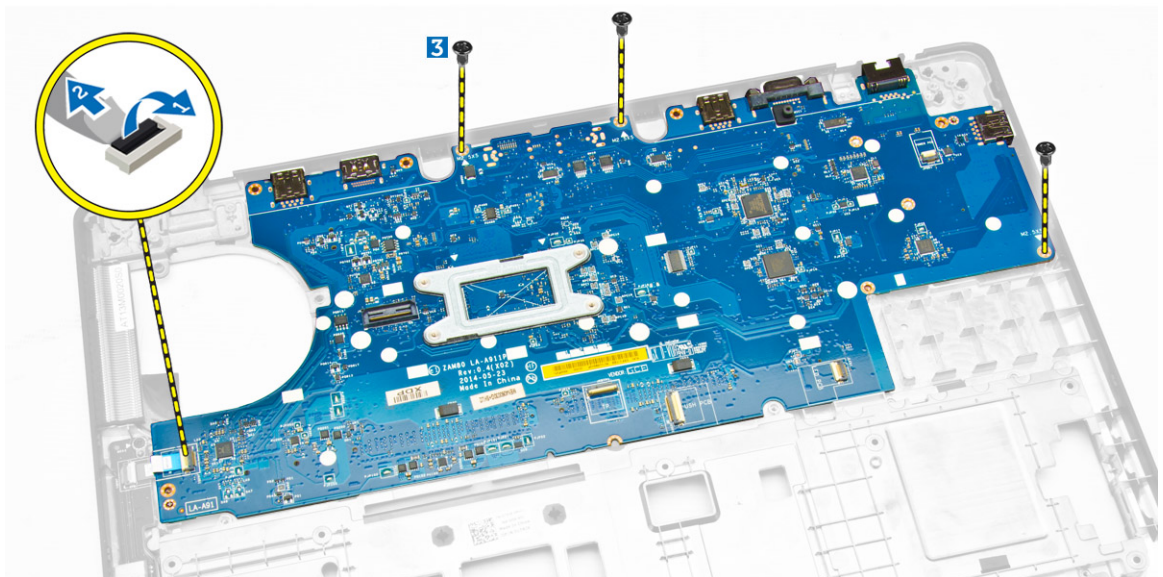

5. Remove the system board from the chassis.

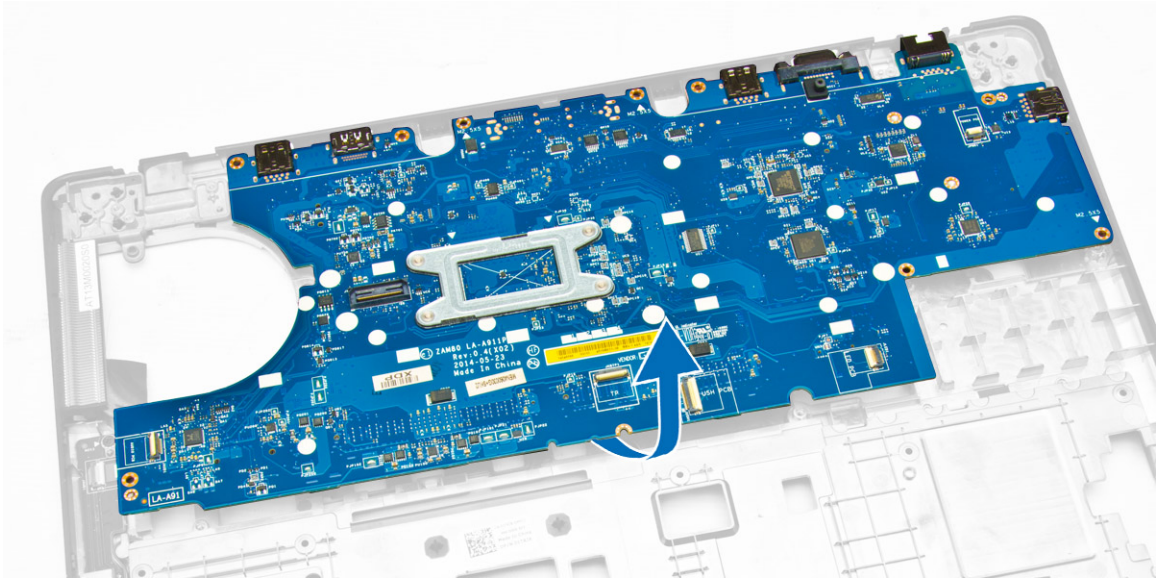

Installing the System Board

1. Place the system board to align with the screw holders on the computer.
2. Tighten the screws to secure the system board to the computer.
3. Connect the following cables to their connectors on the system board:
 - a. audio board
 - b. speaker
 - c. power-connector
4. Install the:
 - a. [system fan](#)
 - b. [display assembly](#)
 - c. [display-hinge brackets](#)
 - d. [palmrest](#)
 - e. [keyboard](#)
 - f. [keyboard trim](#)
 - g. [hard-drive assembly](#)
 - h. [memory](#)
 - i. [battery](#)
 - j. [base cover](#)
5. Follow the procedures in [After Working Inside Your Computer](#).

Removing the Coin-Cell Battery

1. Follow the procedures in [Before Working Inside Your Computer](#).
2. Remove the:
 - a. [base cover](#)
 - b. [battery](#)
 - c. [memory](#)
 - d. [hard-drive assembly](#)

- e. [keyboard trim](#)
 - f. [keyboard](#)
 - g. [palmrest](#)
 - h. [display-hinge brackets](#)
 - i. [display assembly](#)
 - j. [system fan](#)
 - k. [system board](#)
3. Perform the following steps to remove the coin-cell battery from the computer:
- a. Disconnect the coin-cell battery cable from its connector on the system board [1].
 - b. Pry the coin-cell battery to release from the adhesive and remove from the system board [2].

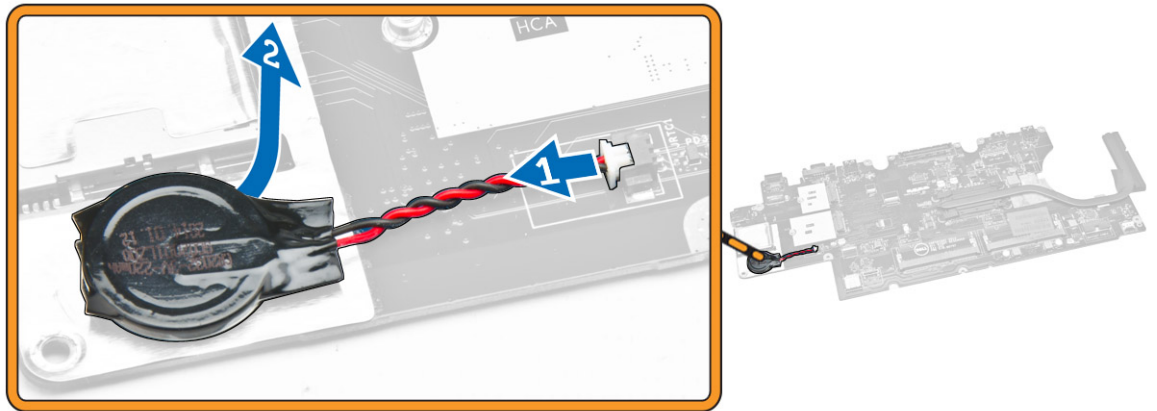

Installing the Coin-Cell Battery

1. Place the coin-cell battery into its slot on the system board.
2. Connect the coin-cell battery cable to its connector on the system board.
3. Install the:
 - a. [system board](#)
 - b. [system fan](#)
 - c. [display assembly](#)
 - d. [display-hinge brackets](#)
 - e. [palmrest](#)
 - f. [keyboard](#)
 - g. [keyboard trim](#)
 - h. [hard-drive assembly](#)
 - i. [memory](#)
 - j. [battery](#)
 - k. [base cover](#)
4. Follow the procedures in [After Working Inside Your Computer](#).

Removing the Heatsink

1. Follow the procedures in [Before Working Inside Your Computer](#).
2. Remove the:

- a. [base cover](#)
 - b. [battery](#)
 - c. [memory](#)
 - d. [keyboard trim](#)
 - e. [keyboard](#)
 - f. [palmrest](#)
 - g. [display-hinge brackets](#)
 - h. [display assembly](#)
 - i. [system fan](#)
 - j. [system board](#)
3. Perform the following steps to remove the heatsink from the system board:
- a. Remove the screws that secure the heatsink on the system board [1].
 - b. Remove the heatsink from the system board [2].

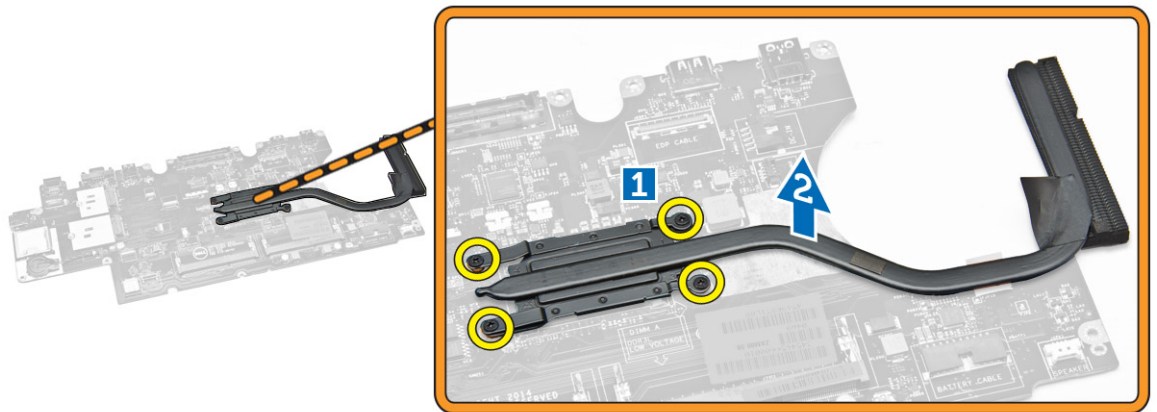

Installing the Heatsink

1. Place the heatsink on the system board and align it with the screw holders.
2. Tighten the screws to secure the heatsink to the system board.
3. Install the:
 - a. [system board](#)
 - b. [system fan](#)
 - c. [display assembly](#)
 - d. [display-hinge brackets](#)
 - e. [palmrest](#)
 - f. [keyboard](#)
 - g. [keyboard trim](#)
 - h. [hard-drive assembly](#)
 - i. [memory](#)
 - j. [battery](#)
 - k. [base cover](#)
4. Follow the procedures in [After Working Inside Your Computer](#).

Removing the Speakers

1. Follow the procedures in [Before Working Inside Your Computer](#).
2. Remove the:
 - a. [base cover](#)
 - b. [battery](#)
 - c. [memory](#)
 - d. [hard-drive assembly](#)
 - e. [keyboard trim](#)
 - f. [keyboard](#)
 - g. [palmrest](#)
 - h. [display-hinge brackets](#)
 - i. [display assembly](#)
 - j. [system fan](#)
 - k. [system board](#)
3. Release the speaker cables from their routing channels.

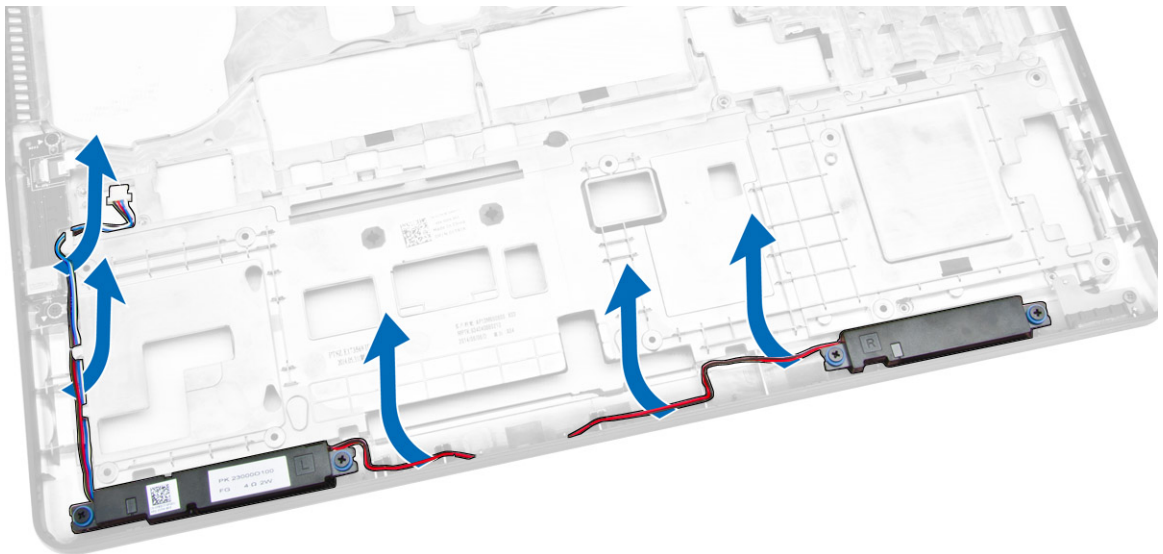

4. Perform the following steps to remove the speakers from the computer:
 - a. Remove the screws that secure the speakers to the computer [1].
 - b. Remove the speakers from the computer [2].

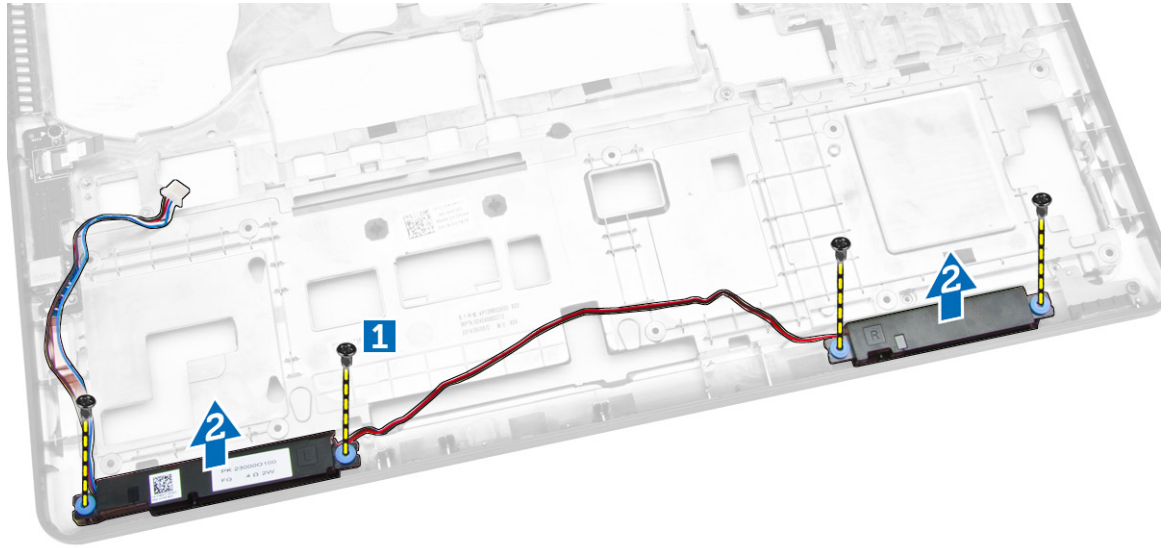

Installing the Speakers

1. Place the speakers into their slots on the computer.
2. Tighten the screws to secure the speakers to the computer.
3. Route the speaker cables through their routing channels.
4. Install the:
 - a. [system board](#)
 - b. [system fan](#)
 - c. [display assembly](#)
 - d. [display-hinge brackets](#)
 - e. [palmrest](#)
 - f. [keyboard](#)
 - g. [keyboard trim](#)
 - h. [hard-drive assembly](#)
 - i. [memory](#)
 - j. [battery](#)
 - k. [base cover](#)
5. Follow the procedures in [After Working Inside Your Computer](#).

System Setup Options

 **NOTE:** Depending on the computer and its installed devices, the items listed in this section may or may not appear.

Table 1. General

Option	Description
System Information	<p>This section lists the primary hardware features of your computer.</p> <ul style="list-style-type: none"> • System Information: Displays BIOS Version, Service Tag, Asset Tag, Ownership Tag, Ownership Date, Manufacture Date, and the Express Service Code. • Memory Information: Displays Memory Installed, Memory Available, Memory Speed, Memory Channels Mode, Memory Technology, DIMM A Size, DIMM B Size, • Processor Information: Displays Processor Type, Core Count, Processor ID, Current Clock Speed, Minimum Clock Speed, Maximum Clock Speed, Processor L2 Cache, Processor L3 Cache, HT Capable, and 64-Bit Technology. • Device Information: Displays Primary Hard Drive, Dock eSATA Device, LOM MAC Address, Video Controller, Video BIOS Version, Video Memory, Panel Type, Native Resolution, Audio Controller, Wi-Fi Device, WiGig Device, Cellular Device, Bluetooth Device.
Battery Information	Displays the battery status and the type of AC adapter connected to the computer
Boot Sequence	<p>Boot Sequence</p> <p>Allows you to change the order in which the computer attempts to find an operating system. The options are:</p> <ul style="list-style-type: none"> • Diskette Drive • Internal HDD • USB Storage Device • CD/DVD/CD-RW Drive • Onboard NIC <p>By default, all the options are checked. You can also deselect any option or change the boot order.</p>
	<p>Boot List Option</p> <p>Allows you to change the boot list option.</p> <ul style="list-style-type: none"> • Legacy • UEFI
Advanced Boot Options	This option allows you the legacy option ROMs to load. By default, the Enable Legacy Option ROMs is disabled.
Date/Time	Allows you to change the date and time.

Table 2. System Configuration

Option	Description
Integrated NIC	Allows you to configure the integrated network controller. The options are: <ul style="list-style-type: none">• Disabled• Enabled• Enabled w/PXE: This option is enabled by default.
Parallel Port	Allows you to configure the parallel port on the docking station. The options are: <ul style="list-style-type: none">• Disabled• AT: This option is enabled by default.• PS2• ECP
Serial Port	Allows you to configure the integrated serial port. The options are: <ul style="list-style-type: none">• Disabled• COM1: This option is enabled by default.• COM2• COM3• COM4
SATA Operation	Allows you to configure the internal SATA hard-drive controller. The options are: <ul style="list-style-type: none">• Disabled• AHCI• RAID On: This option is enabled by default.
Drives	Allows you to configure the SATA drives on board. All drives are enabled by default. The options are: <ul style="list-style-type: none">• SATA-0• SATA-1• SATA-2• SATA-3
SMART Reporting	This field controls whether hard drive errors for integrated drives are reported during system startup. This technology is part of the SMART (Self Monitoring Analysis and Reporting Technology) specification. This option is disabled by default. <ul style="list-style-type: none">• Enable SMART Reporting
USB Configuration	This field configures the integrated USB controller. If Boot Support is enabled, the system is allowed to boot any type of USB Mass Storage Devices (HDD, memory key, floppy). If USB port is enabled, device attached to this port is enabled and available for OS.



Option	Description
	<p>If USB port is disabled, the OS cannot see any device attached to this port.</p> <ul style="list-style-type: none"> • Enable Boot Support • Enable External USB Port • Enable USB3.0 Controller <p> NOTE: USB keyboard and mouse always work in the BIOS setup irrespective of these settings.</p>
USB PowerShare	<p>This field configures the USB PowerShare feature behavior. This option allows you to charge external devices using the stored system battery power through the USB PowerShare port.</p>
Audio	<p>This field enables or disables the integrated audio controller. By default, the Enable Audio option is selected.</p>
Keyboard Illumination	<p>This field lets you choose the operating mode of the keyboard illumination feature.</p> <p>The keyboard brightness level can be set from 0% to 100%</p> <ul style="list-style-type: none"> • Disabled • Dim • Bright <p>This option is disabled by default.</p>
Keyboard Backlight with AC	<p>The Keyboard Backlight with AC option does not affect the main keyboard illumination feature. Keyboard Illumination will continue to support the various illumination levels. This field has an effect when the backlight is enabled.</p>
Unobtrusive Mode	<p>This option, when enabled, pressing Fn+F7 turns off all light and sound emissions in the system. To resume normal operation, press Fn+F7 again. This option is disabled by default.</p>
Miscellaneous Devices	<p>Allows you to enable or disable the following devices:</p> <ul style="list-style-type: none"> • Enable Microphone • Enable Camera • Enable Hard Drive Free Fall Protection • Enable Media Card • Disable Media Card <p> NOTE: All devices are enabled by default.</p> <p>You can also enable or disable Media Card.</p>

Table 3. Video

Option	Description
LCD Brightness	Allows you to set the display brightness depending up on the power source (On Battery and On AC).







 **NOTE:** The Video setting will only be visible when a video card is installed into the system.

Table 4. Security

Option	Description
Admin Password	<p>Allows you to set, change, or delete the administrator (admin) password.</p> <p> NOTE: You must set the admin password before you set the system or hard drive password. Deleting the admin password automatically deletes the system password and the hard drive password.</p> <p> NOTE: Successful password changes take effect immediately.</p> <p>Default Setting: Not set</p>
System Password	<p>Allows you to set, change or delete the system password.</p> <p> NOTE: Successful password changes take effect immediately.</p> <p>Default Setting: Not set</p>
Internal HDD-1 Password	<p>Allows you to set, change or delete the password on the system's internal hard-disk drive.</p> <p> NOTE: Successful password changes take effect immediately.</p> <p>Default Setting: Not set</p>
Strong Password	<p>Allows you to enforce the option to always set strong passwords.</p> <p>Default Setting: Enable Strong Password is not selected.</p> <p> NOTE: If Strong Password is enabled, Admin and System passwords must contain at least one uppercase character, one lowercase character and be at least 8 characters long.</p>
Password Configuration	Allows you to determine the minimum and maximum length of Administrator and System passwords.
Password Bypass	<p>Allows you to enable or disable the permission to bypass the System and the Internal HDD password, when they are set. The options are:</p> <ul style="list-style-type: none"> • Disabled • Reboot bypass <p>Default Setting: Disabled</p>
Password Change	Allows you to enable the disable permission to the System and Hard Drive passwords when the admin password is set.

Option	Description
	Default Setting: Allow Non-Admin Password Changes is selected.
Non-Admin Setup Changes	Allows you to determine whether changes to the setup options are allowed when an Administrator Password is set. If disabled the setup options are locked by the admin password.
TPM Security	Allows you to enable the Trusted Platform Module (TPM) during POST. Default Setting: The option is disabled.
Computrace	Allows you to activate or disable the optional Computrace software The options are: <ul style="list-style-type: none"> • Deactivate • Disable • Activate <p> NOTE: The Activate and Disable options will permanently activate or disable the feature and no further changes will be allowed</p> Deactivate (default)
CPU XD Support	Allows you to enable the Execute Disable mode of the processor. Enable CPU XD Support (default)
OROM Keyboard Access	Allows you to set an option to enter the Option ROM Configuration screens using hotkeys during boot. The options are: <ul style="list-style-type: none"> • Enable • One Time Enable • Disable Default Setting: Enable
Admin Setup Lockout	Allows you to prevent users from entering Setup when an Administrator password is set. Default Setting: Enable Admin Setup Lockout is not selected.

Table 5. Secure Boot

Option	Description
Secure Boot Enable	This option enables or disables the Secure Boot Feature. <ul style="list-style-type: none"> • Disabled • Enabled Default Setting: The option is enabled.
Expert Key Management	Allows you to manipulate the security key databases only if the system is in Custom Mode. The Enable Custom Mode option is disabled by default. The options are: <ul style="list-style-type: none"> • PK



Option	Description
	<ul style="list-style-type: none"> • KEK • db • dbx <p>If you enable the Custom Mode, the relevant options for PK, KEK, db, and dbx appear. The options are:</p> <ul style="list-style-type: none"> • Save to File- Saves the key to a user-selected file • Replace from File- Replaces the current key with a key from a user-selected file • Append from File- Adds a key to the current database from a user-selected file • Delete- Deletes the selected key • Reset All Keys- Resets to default setting • Delete All Keys- Deletes all the keys <p> NOTE: If you disable the Custom Mode, all the changes made will be erased and the keys will restore to default settings.</p>

Table 6. Performance

Option	Description
Multi Core Support	<p>This field specifies whether the process will have one or all cores enabled. The performance of some applications will improve with the additional cores. This option is enabled by default. Allows you to enable or disable multi-core support for the processor. The installed processor supports two cores. If you enable Multi Core Support, two cores will be enabled. If you disable Multi Core Support, one core will be enabled.</p> <ul style="list-style-type: none"> • Enable Multi Core Support <p>Default Setting: The option is enabled.</p>
Intel SpeedStep	<p>Allows you to enable or disable the Intel SpeedStep feature.</p> <ul style="list-style-type: none"> • Enable Intel SpeedStep <p>Default Setting: The option is enabled.</p>
C-States Control	<p>Allows you to enable or disable the additional processor sleep states.</p> <ul style="list-style-type: none"> • C states <p>Default Setting: The option is enabled.</p>
Hyper-Thread Control	<p>Allows you to enable or disable the Hyper-Threading in the processor.</p> <ul style="list-style-type: none"> • Disabled • Enabled <p>Default Setting: The option is enabled.</p>

Table 7. Power Management

Option	Description
AC Behavior	Allows you to enable or disable the computer from turning on automatically when an AC adapter is connected. Default Setting: Wake on AC is not selected.
Auto On Time	Allows you to set the time at which the computer must turn on automatically. The options are: <ul style="list-style-type: none">• Disabled (default)• Every Day• Weekdays• Select Days
USB Wake Support	Allows you to enable USB devices to wake the system from Standby.  NOTE: This feature is only functional when the AC power adapter is connected. If the AC power adapter is removed during Standby, the system setup will remove power from all of the USB ports to conserve battery power. <ul style="list-style-type: none">• Enable USB Wake Support Default Setting: The option is disabled.
Wireless Radio Control	Allows you to enable or disable the feature that automatically switches from wired or wireless networks without depending on the physical connection. <ul style="list-style-type: none">• Control WLAN Radio• Control WWAN Radio Default Setting: The option is disabled.
Wake on LAN/WLAN	Allows you to enable or disable the feature that powers on the computer from the Off state when triggered by a LAN signal. <ul style="list-style-type: none">• Disabled: This option is enabled by default• LAN Only• WLAN Only• LAN or WLAN
Block Sleep	This option lets you block entering to sleep (S3 state) in Operating System environment. Block Sleep (S3 state) - This option is disabled by default.
Peak Shift	This option enables you to minimize the AC power consumption during the peak power times of day. After you enable this option, your system runs only in battery even if the AC is attached.
Advanced Battery Charge Configuration	This option enables you to maximize the battery health. By enabling this option, your system uses the standard charging algorithm and other techniques, during the non-work hours to improve the battery health.



Option	Description
	Disabled (default)
Primary Battery Charge Configuration	<p>Allows you to select the charging mode for the battery. The options are:</p> <ul style="list-style-type: none"> • Adaptive • Standard - Fully charges your battery at a standard rate. • ExpressCharge - The battery charges over a shorter period of time using Dell's fast charging technology. This option is enabled by default. • Primarily AC use • Custom <p>If Custom Charge is selected, you can also configure Custom Charge Start and Custom Charge Stop.</p> <p> NOTE: All charging mode may not be available for all the batteries. To enable this option, disable the Advanced Battery Charge Configuration option.</p>
Intel Smart Connect Technology	<p>This option, if enabled, periodically senses the nearby wireless connections, while the system is in sleep state. You can use this option to synchronize the email or other social media applications that are open, when the system enters the sleep state.</p>

Table 8. POST Behavior

Option	Description
Adapter Warnings	<p>Allows you to enable or disable the system setup (BIOS) warning messages when you use certain power adapters.</p> <p>Default Setting: Enable Adapter Warnings</p>
Keypad (Embedded)	<p>Allows you to choose one of two methods to enable the keypad that is embedded in the internal keyboard.</p> <ul style="list-style-type: none"> • Fn Key Only: This option is enabled by default. • By Numlock <p> NOTE: When setup is running, this option has no effect. Setup works in Fn Key Only mode.</p>
Mouse/Touchpad	<p>Allows you to define how the system handles mouse and touch pad input. The options are:</p> <ul style="list-style-type: none"> • Serial Mouse • PS2 Mouse • Touchpad / PS-2 Mouse: This option is enabled by default.
Numlock Enable	<p>Allows you to enable the Numlock option when the computer boots.</p> <p>Enable Network</p> <p>This option is enabled by default.</p>

Option	Description
Fn Key Emulation	Allows you to set the option where the <Scroll Lock> key is used to simulate the <Fn> key feature. Enable Fn Key Emulation (default)
Fn Lock Options	Allows you to let hot key combinations <Fn> + <Esc> toggle the primary behavior of F1–F12, between their standard and secondary functions. If you disable this option, you cannot toggle dynamically the primary behavior of these keys. The available options are: <ul style="list-style-type: none"> • Fn Lock. This option is selected by default. • Lock Mode Disable / Standard • Lock Mode Enable / Secondary
Fastboot	Allows you to speed up the boot process by bypassing some of the compatibility steps. The options are: <ul style="list-style-type: none"> • Minimal • Thorough (default) • Auto
Extended BIOS POST Time	Allows you to create an additional pre-boot delay. The options are: <ul style="list-style-type: none"> • 0 seconds. This option is enabled by default. • 5 seconds • 10 seconds

Table 9. Virtualization Support

Option	Description
Virtualization	Allows you to enable or disable the Intel Virtualization Technology. Enable Intel Virtualization Technology (default)
VT for Direct I/O	Enables or disables the Virtual Machine Monitor (VMM) from utilizing the additional hardware capabilities provided by Intel® Virtualization technology for direct I/O. Enable VT for Direct I/O - enabled by default.

Table 10. Wireless

Option	Description
Wireless Switch	Allows to set the wireless devices that can be controlled by the wireless switch. The options are: <ul style="list-style-type: none"> • WWAN • GPS (on WWAN Module) • WLAN/WiGig • Bluetooth All the options are enabled by default.

Option	Description
	 NOTE: For WLAN and WiGig enable or disable controls are tied together and they cannot be enabled or disabled independently.
Wireless Device Enable	<p>Allows you to enable or disable the internal wireless devices.</p> <ul style="list-style-type: none"> • WWAN / GPS • WLAN / WiGig • Bluetooth <p>All the options are enabled by default.</p>



Table 11. Maintenance

Option	Description
Service Tag	Displays the Service Tag of your computer.
Asset Tag	Allows you to create a system asset tag if an asset tag is not already set. This option is not set by default.

Table 12. System Logs

Option	Description
BIOS Events	Allows you to view and clear the System Setup (BIOS) POST events.
Thermal Events	Allows you to view and clear the System Setup (Thermal) events.
Power Events	Allows you to view and clear the System Setup (Power) events.

Technical Specifications

 **NOTE:** Offerings may vary by region. For more information regarding the configuration of your computer, click Start  (**Start icon**) → **Help and Support**, and then select the option to view information about your computer.

 **NOTE:** In Windows 8.1, navigate to **Help and Support** to view information about your computer.

Table 13. System Information

Feature	Specification
Chipset	Intel 4th Generation Processors / Intel 5th Generation Processors
DRAM bus width	64-bit
Flash EPROM	SPI 32 Mbits, 64 Mbits
PCIe bus	100 MHz
External Bus Frequency	PCIe Gen2 (5 GT/s)

Table 14. Processor

Feature	Specification	
	Intel 4th Generation Processors	Intel 5th Generation Processors
Types	Intel Core i3 / i5	Intel Core i3 / i5 / i7
L3 cache		
i3	3 MB	3 MB
i5	3 MB	3 MB
i7	NA	4MB

Table 15. Memory

Feature	Specification
Memory connector	two SODIMM slots
Memory capacity	
Intel 4th Generation Processors	4 GB or 8 GB
Intel 5th Generation Processors	4 GB, 8 GB, or 16 GB
Memory type	DDR3L SDRAM (1600 MHz)
Minimum memory	4 GB

Feature	Specification
Maximum memory	
Intel 4th Generation Processors	8 GB
Intel 5th Generation Processors	16 GB

Table 16. Audio

Feature	Specification
Type	High-definition audio
Controller	Realtek ALC3235
Stereo conversion	Digital Audio-out through HDMI - up to 7.1 compressed and un-compressed audio
Interface:	
Internal	high-definition audio codec
External	Stereo headset / mic combo
Speakers	two
Internal speaker amplifier	2 W (RMS) per channel
Volume controls	hot keys

Table 17. Video

Feature	Specification
Type	integrated on system board, hardware accelerated
Controller:	
UMA	
Intel 4th Generation Processors	i3 / i5 HD Graphics 4400
Intel 5th Generation Processors	i3 / i5 / i7 HD Graphics 5500
Discrete	
Intel 4th Generation Processors	NA
Intel 5th Generation Processors	<ul style="list-style-type: none"> • nVIDIA N15-GM • nVIDIA N15-GT
Data bus	Integrated video
External display support	<ul style="list-style-type: none"> • 19-pin HDMI connector • 15-pin DSUB VGA connector

Table 18. Camera

Features	Specification
Camera Resolution	1280 x 720 pixels
Video Resolution (maximum)	1280 x 720 pixels
Diagonal viewing angle	74°

Table 19. Communications

Features	Specification
Network adapter	10/100/1000 Mb/s Ethernet (RJ-45)
Wireless	internal wireless local area network (WLAN) and wireless wide area network (WWAN).  NOTE: WWAN is optional.

Table 20. Ports and Connectors

Features	Specification
Audio	Stereo headset / mic combo
Video	<ul style="list-style-type: none"> one 19-pin HDMI connector one 15-pin DSUB VGA connector
Network adapter	one RJ-45 connector
USB	Three USB 3.0, one-powered compliant connector
Memory card reader	supports up to SD4.0
Micro Subscriber Identity Module (uSIM) card	one (optional)  NOTE: Removal of base cover is required.
Docking port	one (optional)

Table 21. Contactless Smart Card

Feature	Specification
Supported Smart Cards/Technologies	BTO with USH

Table 22. Display

Feature	Specification			
	Non-Touch HD Anti-Glare	Non-Touch FHD Anti-Glare	Touch FHD (eTP)	Touch HD Panel
Dimensions:				
Height	3.20 mm (0.13 inch)	3.20 mm (0.13 inch)	5.40 mm (0.21 inch)	5.00 mm (0.19 inch)

Feature	Specification			
Width	360 mm x 224.30 mm (14.17 inches x 8.83 inches)	359.50 mm x 223.80 mm (14.15 inches x 8.81 inches)	366.63 mm x 225.06 mm (14.43 inches x 10.04 inches)	360 mm x 224.30 mm (14.17 inches x 8.83 inches)
Diagonal	396.24 mm (15.6 inches)	396.24 mm (15.6 inches)	396.24 mm (15.6 inches)	396.24 mm (15.6 inches)
Active area (X/Y)	344.23 mm x 193.54 mm (13.55 inches x 7.62 inches)	344.16 mm x 193.59 mm (13.54 inches x 7.62 inches)	344.16 mm x 193.59 mm (13.54 inches x 7.62 inches)	344.23 mm x 193.54 mm (13.55 inches x 7.62 inches)
Maximum resolution	1366 x 768	1920 x 1080	1920 x 1080	1366 x 768
Maximum Brightness	200 nits	300 nits	270 nits	200 nits
Refresh rate	60 Hz	60 Hz	60 Hz	60 Hz
Minimum Viewing Angles:				
Horizontal	40/40	80/80	80/80	40/40
Vertical	10/30	80/80	80/80	10/30
Pixel pitch	0.252 x 0.252	0.17925 x 0.17925	0.179 x 0.179	0.252 x 0.252

Table 23. Keyboard

Feature	Specification	
	Backlit KB	Non-Backlit KB
Number of keys	United States: 106 keys, United Kingdom: 107 keys, Brazil: 109 keys, and Japan: 110 keys	

Table 24. Touchpad

Feature	Specification
Active Area:	
X-axis	99.50 mm
Y-axis	53.00 mm

Table 25. Battery

Feature	3-Cell (38 Whr)	4-Cell (51 Whr)
Type		
Dimensions:		
Depth	177.50 mm (6.98 inches)	233.00 mm (9.17 inches)
Height	7.05 mm (0.27 inch)	7.05 mm (0.27 inch)

Feature		
Width	94.80 mm (3.73 inches)	94.80 mm (3.73 inches)
Weight	265 g (0.58 lb)	340 g (0.75 lb)
Voltage	11.1 VDC	7.4 VDC
Temperature range:		
Operating	<ul style="list-style-type: none"> • Charge: 0 °C to 50 °C • Discharge: 0 °C to 70 °C • Operating: 0° to 35° C (32° to 95° F) 	
Non-Operating	- 40 °C to 65 °C (- 40 °F to 149 °F)	
Coin-cell battery	3 V CR2032 lithium coin cell	

Table 26. AC Adapter

Feature	Specification
Type	65 W and 90 W  NOTE: 90 W is shipped to India and is optional to other regions
Input voltage	100 VAC to 240 VAC
Input current (maximum)	1.5 A
Input frequency	50 Hz to 60 Hz
Output current	3.34 A and 4.62 A
Rated output voltage	19.5 +/- 1.0 VDC
Temperature range:	
Operating	0 °C to 40 °C (32 °F to 104 °F)
Non-Operating	-40 °C to 70 °C (-40 °F to 158 °F)

Table 27. Physical

Feature		Glass Fiber Reinforced Polymer Cover W/O Touch	Mag Cover W/O Touch	Mag Cover With Touch
Height	Front	20.60 mm (0.81 inch)	20.60 mm (0.81 inch)	20.60 mm (0.81 inch)
	Back	23.45 mm (0.92 inch)	23.60 mm (0.93 inch)	24.25 mm (0.95 inch)
Width		376.90 mm (14.84 inches)	376.90 mm (14.84 inches)	376.90 mm (14.84 inches)
Depth		255.20 mm (8.87 inches)	255.20 mm (8.87 inches)	255.20 mm (8.87 inches)
Weight		4.71 lb (2.13 kg)	4.71 lb (2.13 kg)	4.71 lb (2.13 kg)

Table 28. Environmental

Feature	Specification
Temperature:	
Operating	0 °C to 35 °C (32 °F to 95 °F)
Storage	-40 °C to 65 °C (-40 °F to 149 °F)
Relative humidity (maximum):	
Operating	10 % to 90 % (non condensing)
Storage	5 % to 95 % (non condensing)
Altitude (maximum):	
Operating	0 m to 3048 m (0 ft to 10,000 ft) 0° to 35°C
Non-Operating	0 m to 10,668 m (0 ft to 35,000 ft)
Airborne contaminant level	G1 as defined by ISA-71.04-1985

Diagnostics

If you experience a problem with your computer, run the ePSA diagnostics before contacting Dell for technical assistance. The purpose of running diagnostics is to test your computer's hardware without requiring additional equipment or risking data loss. If you are unable to fix the problem yourself, service and support personnel can use the diagnostics results to help you solve the problem.

Enhanced Pre-Boot System Assessment (ePSA) Diagnostics

The ePSA diagnostics (also known as system diagnostics) performs a complete check of your hardware. The ePSA is embedded with the BIOS and is launched by the BIOS internally. The embedded system diagnostics provides a set of options for particular devices or device groups allowing you to:

- Run tests automatically or in an interactive mode
- Repeat tests
- Display or save test results
- Run thorough tests to introduce additional test options to provide extra information about the failed device(s)
- View status messages that inform you if tests are completed successfully
- View error messages that inform you of problems encountered during testing

 **CAUTION: Use the system diagnostics to test only your computer. Using this program with other computers may cause invalid results or error messages.**

 **NOTE:** Some tests for specific devices require user interaction. Always ensure that you are present at the computer terminal when the diagnostic tests are performed.

You can launch the ePSA diagnostics by two ways:





1. Power-on the computer.
2. As the computer boots, press the <F12> key as the Dell logo appears.
3. On the boot menu screen, select the **Diagnostics** option.
The **Enhanced Pre-boot System Assessment** window displays, listing all devices detected in the computer. The diagnostics starts running the tests on all the detected devices.
4. If you wish to run a diagnostic test on a specific device, press <Esc> and click **Yes** to stop the diagnostic test.
5. Select the device from the left pane and click **Run Tests**
6. If there are any issues, error codes are displayed.
Note the error code and contact Dell.

OR

1. Shutdown the computer.
2. Press and hold the <fn> key, while pressing the power button, and then release both.
The **Enhanced Pre-boot System Assessment** window displays, listing all devices detected in the computer. The diagnostics starts running the tests on all the detected devices.
3. On the boot menu screen, select the **Diagnostics** option.
The **Enhanced Pre-boot System Assessment** window displays, listing all devices detected in the computer. The diagnostics starts running the tests on all the detected devices.
4. If you wish to run a diagnostic test on a specific device, press <Esc> and click **Yes** to stop the diagnostic test.
5. Select the device from the left pane and click **Run Tests**
6. If there are any issues, error codes are displayed.
Note the error code and contact Dell.

Device Status Lights

Table 29. Device Status Lights

	Turns on when you turn on the computer and blinks when the computer is in a power management mode.
	Turns on when the computer reads or writes data.
	Turns on steadily or blinks to indicate battery charge status.
	Turns on when wireless networking is enabled.

The device status LEDs are usually located either on the top or left side of the keyboard. They display the storage, battery and wireless devices connectivity and activity. Apart from that they can be useful as a diagnostic tool when there's a possible failure to the system.

The following table lists how to read the LED codes when possible errors occur.

Table 30. LED Lights

Storage LED	Power LED	Wireless LED	Fault Description
Blinking	Solid	Solid	A possible processor failure has occurred.
Solid	Blinking	Solid	The memory modules are detected but encountered an error.
Blinking	Blinking	Blinking	A system board failure has occurred.
Blinking	Blinking	Solid	A possible graphics card/video failure has occurred.
Blinking	Blinking	Off	System failed on hard drive initialization OR System failed in Option ROM initialization.
Blinking	Off	Blinking	The USB controller encountered a problem during initialization.
Solid	Blinking	Blinking	No memory modules are installed/detected.

Storage LED	Power LED	Wireless LED	Fault Description
Blinking	Solid	Blinking	The display encountered a problem during initialization.
Off	Blinking	Blinking	The modem is preventing the system from completing POST
Off	Blinking	Off	Memory failed to initialize or memory is unsupported.

Battery Status Lights

If the computer is connected to an electrical outlet, the battery light operates as follows:

Alternately blinking amber light and white light	An unauthenticated or unsupported non-Dell AC adapter is attached to your laptop.
Alternately blinking amber light with steady white light	Temporary battery failure with AC adapter present.
Constantly blinking amber light	Fatal battery failure with AC adapter present.
Light off	Battery in full charge mode with AC adapter present.
White light on	Battery in charge mode with AC adapter present.

Contacting Dell

 **NOTE:** If you do not have an active Internet connection, you can find contact information on your purchase invoice, packing slip, bill, or Dell product catalog.

Dell provides several online and telephone-based support and service options. Availability varies by country and product, and some services may not be available in your area. To contact Dell for sales, technical support, or customer service issues:

1. Go to **dell.com/support**.
2. Select your support category.
3. Verify your country or region in the **Choose a Country/Region** drop-down list at the bottom of the page.
4. Select the appropriate service or support link based on your need.